

**MOSSER**  
industrias

PARQUES INFANTILES  
**ECOLÓGICOS**



**Compakt**  
Natural Concrete



**playfor**

C/ África, 15 - P.I. La Serreta - 30500 - Molina de Segura - MURCIA  
968 823 362 - info@industriasmosser.com



# GUÍA DE CATÁLOGO

## INICIO

Puedes leer el catálogo de forma clásica o usar los enlaces de abajo para acceder directamente al apartado que más te interese. Para volver a esta página, puedes clicar los rectángulos laterales de cada página.

---

**INTRO**

**CERT.**

**TIPS&  
TRICKS**

**MAT.**

**ÍNDICE**

## **Jugar es mucho más que divertirse.**

Es crecer, imaginar, compartir,  
aprender a caer y volver a levantarse.  
Es la base de la inclusión, la creatividad  
y el desarrollo social desde la infancia.

---

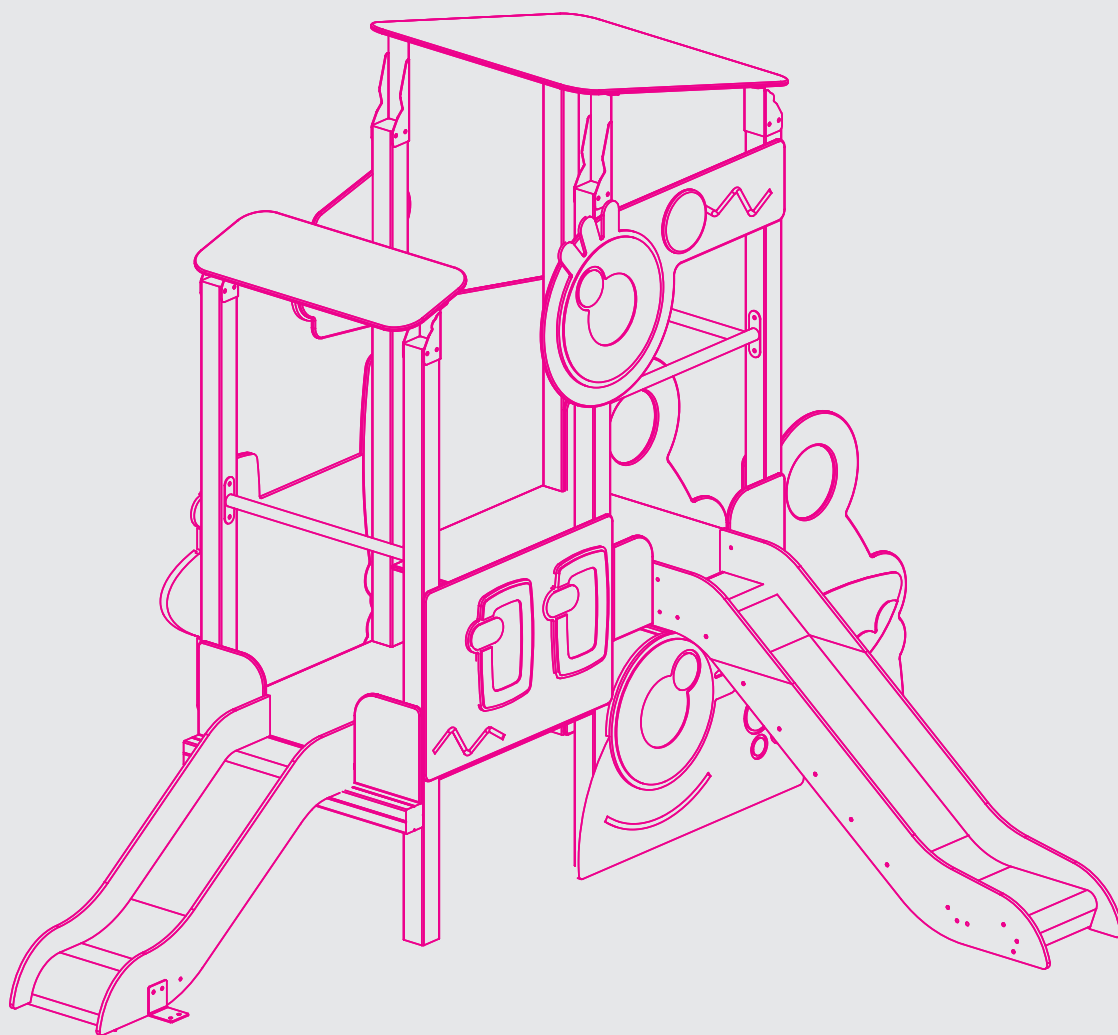

**Creamos espacios  
donde el juego  
se convierte en experiencia.**



# POR QUÉ JUGAMOS? PARA QUÉ JUGAMOS?

ES\_

Diversión, aprendizaje, salud y nuevas amistades. Cada uno de estos puntos es tanto o más importante que el siguiente o el anterior. Hoy en día, la sociedad vive inmersa en un entorno lleno de prisa, estrés, obligaciones y responsabilidades de las cuales es necesario desconectar. Los niños necesitan actividad física, aire libre, sonrisas y diversión para ser capaces de adaptarse a todo su entorno y crecer con salud y consciencia.

El hecho de jugar en los parques infantiles fomenta las relaciones entre ellos, el respeto mutuo y el respeto hacia el entorno, hacen ejercicio y se divierten libremente, sin obligaciones ni reglas a seguir. Les ayudamos a potenciar su imaginación, a desarrollar sus propios juegos y actividades, a ponerse nuevos retos y descubrir nuevas sensaciones a las que hacer frente.

Los parques infantiles se convierten en puntos de encuentro, de desahogo. Les ayuda a desconectar de las pocas obligaciones que tienen y los convierte en lo que son: niños. Su máxima preocupación pasa a ser como trepar, como llegar hasta arriba, como bajar un tobogán o como saltar de un lado a otro.

La felicidad de los más pequeños se contagia a los adultos, son momentos de tranquilidad, felicidad y de alegría al ver como desarrollan nuevas habilidades, como hacen nuevos amigos y como hacen, sin saberlo, que el entorno deje de girar rápido y pierda importancia.

**Jugamos porque nos gusta  
JUGAMOS PARA DISFRUTAR**

EN\_

Fun, learning, health and new friendships. Each one of these points is as much or more important than the next or the previous one. Nowadays, society lives immersed in an environment full of haste, stress, obligations and responsibilities of which it's necessary to disconnect. Children need physical activity, fresh air, smiles and fun to be able to adapt to their entire environment and grow with health and awareness.

Playing in playgrounds encourages relationships between them, mutual respect and respect for the environment, exercise and have fun freely, without obligations or rules to follow. We help to strengthen their imagination, to develop their own games and activities, to notice new challenges and discover new sensations to face.

The playgrounds become meeting points, to relief. It helps them to disconnect from the few obligations they have and makes them what they are: children. Their maximum concern becomes like climb, how to get to the top, how to go down a slide or how to jump off a side to side.

Their happiness is transported and project towards adults. Are moments of tranquillity and happiness, of joy to see how they develop new skills, how they make new friends and how they do, without knowing it, that the environment stop spinning fast and lose importance.

**We play because we like it  
WE PLAY TO ENJOY**

FR\_

Divertissement, apprentissage, santé et nouvelles amitiés. Tous ces points sont tout aussi importants que les autres. Aujourd'hui, la société vit plongée dans un environnement pressé, stressé, rempli d'obligations et de responsabilités dont il faut pouvoir se déconnecter. Les enfants ont besoin d'activité physique, de plein air, de sourires et d'amusement pour pouvoir s'adapter à leur environnement et grandir en pleine santé physique et psychique.

S'amuser dans les aires de jeux leur permet de créer des relations entre eux, encourage le respect mutuel et celui de l'environnement, ils font de l'exercice et s'amuse librement, sans obligations ni règles contraignantes. Nous les aidons à développer leur imagination, à vivre leurs propres jeux et activités, à relever de nouveaux défis et à découvrir de nouvelles sensations à éprouver.

Les aires de jeux deviennent des points de rencontre, de détente. Celles-ci les aident à se déconnecter des quelques obligations qu'ils ont et les aident à rester ce qu'ils sont : des enfants. Leur principale préoccupation est de savoir comment grimper, comment atteindre le sommet, comment descendre un toboggan ou comment sauter d'un côté à l'autre.

Ce bonheur partagé rejaille sur les adultes. Ce sont des moments de tranquillité et de joie, où l'on se félicite de voir comment ils développent de nouvelles compétences, comment ils se font de nouveaux amis et comment ils font, sans le savoir, ralentir le temps et nous échapper de la vie quotidienne.

**Nous jouons parce que nous  
aimons ça  
NOUS JOUONS POUR NOUS  
AMUSER**

# QUIÉNES SOMOS?

## ES\_

Somos una empresa dedicada a la fabricación de productos relacionados con las áreas de juegos infantiles y el mobiliario de espacios urbanos.

Disponemos de todos los medios tanto de diseño como productivos para el desarrollo de los mismos siendo nuestro principal proceso la manipulación del plástico (hdpe), metal (hierro y acero inoxidable) cuerda y madera.

Nos avalan más de 24 años de experiencia en la creación de elementos para el desarrollo del juego infantil.

Nuestro compromiso con la lucha por el derecho de los niños a jugar se percibe en el juego como un medio indispensable para el desarrollo integral infantil.

Garantizamos nuestro sistema productivo, durabilidad, estética y funcionalidad como valor fundamental.

## EN\_

We are a company dedicated to the manufacture of related products with playgrounds and furniture for urban spaces.

We have all the means of design and production for their development being our main processes the handling of plastic (HDPE), metal (iron and stainless steel), rope and wood.

We are backed by more than 24 years of experience in creating elements for the development of children's play.

Our commitment to the fight for the right of children to play is perceived in the game as an indispensable means for development children's integral.

We guarantee our productive system, durability, aesthetics and functionality as a fundamental value.

## FR\_

Nous sommes une entreprise dédiée à la fabrication de produits relatifs aux aires de jeux pour enfants, mais aussi au mobilier des espaces urbains.

Nous disposons de tous les moyens de conception et de production pour leur développement, nos principaux processus utilisant aussi bien le plastique (hdpe), le métal (fer et inox), la corde et le bois.

Nous avons plus de 15 ans d'expérience dans la création d'éléments favorisant le jeu pour enfants.

Notre engagement dans la lutte pour le droit des enfants à jouer se traduit à travers nos jeux, le jeu étant un outil incontournable pour le développement intégral des enfants.

Nous garantissons notre système de production et la durabilité ; l'esthétique et la fonctionnalité sont pour nous des valeurs fondamentales.



# NUESTRO PRINCIPAL OBJETIVO

ES\_

Es crear áreas de juegos adecuados a las edades de cada niño, diseñados para todos ellos e integrados en cada uno de los entornos y que permitan intensificar su actividad física, social, emocional y creativa con el fin de aumentar su nivel de diversión. Nuestro equipo humano está formado por una serie de profesionales en todas las áreas, tanto del diseño como de la producción y su posterior asesoramiento y comercialización, basando nuestro principal compromiso en una mejora continua.

Escuchamos las necesidades crecientes del mercado y trabajamos en base a sus criterios, asegurando resultados finales que cumplan los requisitos y requerimientos necesarios.

Somos una empresa con un gran conocimiento de las necesidades del sector, joven y dinámica. Por ello nuestros estándares de calidad son valores que no podemos dejar atrás considerando cada una de las normativas vigentes y respetando el medio ambiente.

Por ello colaboramos con las principales agencias de certificación e inspección: accm, Enac, etc... además de estar plenamente comprometidos con la calidad y el medioambiente, aplicando certificados como DFEE o FSC

## MEJORA SOCIAL

Nuestro compromiso con la seguridad es el estandarte de nuestros productos, teniendo este concepto presente desde el nacimiento y conceptualización de nuestro catálogo. A esto le tenemos que sumar nuestra política de integración, la cual conlleva a crear parques en los que hay cabida para todos los niños!

EN\_

It's to create playgrounds appropriate to the ages of each child, designed for all of them and integrated into each of the environments and that allow intensify their physical, social emotional and creative activity in order to increase their level of fun.

Our Human Team is formed by a series of professionals in all areas, both design and production and subsequent advice and marketing, basing our main commitment on continuous improvement.

We listen to the growing needs of the market and work in based on your criteria, ensuring final results that meet the necessary requirements.

We are a company with a great knowledge of the needs of the sector, young and dynamic. That is why our quality standards are values that we cannot leave behind considering each of the current regulations and respecting the environment.

Therefore we collaborate with the main certification agencies and inspection: ACCM, ENAC, etc ... besides being fully committed to quality and the environment, applying certificates as DFEE or FSC.

## SOCIAL IMPROVEMENT

Our commitment to security it's the banner of our products, keeping this concept in mind since the birth and conceptualization of our catalogue. To this we have to add our integration policy, which leads to create parks where there's room for all children!

FR\_

Il s'agit de créer des aires de jeux adaptées à l'âge de chaque enfant, conçues pour chacun d'entre eux, intégrées dans tout type d'environnement et qui permettent d'augmenter leur activité physique, sociale, émotionnelle et créative afin d'augmenter leur niveau de plaisir.

Notre équipe est constituée de professionnels dans tous les domaines, de la conception à la la production, au marketing et au conseil, avec comme engagement principal de faire toujours mieux.

Nous sommes à l'écoute des besoins émergents du marché et travaillons en fonction de vos critères, garantissant des résultats finaux qui répondent à vos exigences et aux normes nécessaires.

Nous sommes une entreprise avec une grande connaissance des besoins du secteur, jeune et dynamique. Aussi nos normes de qualité sont aussi des valeurs que nous ne pouvons laisser de côté et qui prennent en compte chacune des réglementations en vigueur ainsi que le respect de l'environnement.

Par conséquent, nous collaborons avec les principales agences de certification et d'inspection: accm, Enac, etc ... en plus d'être pleinement engagés dans la recherche de qualité et le respect de l'environnement, en appliquant des certificats tels que DFEE ou FSC

## AMÉLIORATION SOCIALE

Nos engagements en matière de sécurité se traduisent dans tous nos produits, ce concept étant présent dès la naissance et la conceptualisation de notre catalogue. À cela, il faut ajouter notre politique d'intégration, ce qui conduit à la création de parcs où chaque enfant a sa place!



# NUESTRA CALIDAD

## CERTIFICACIONES

### ES\_

Trabajamos directamente con empresas certificadoras independientes certificadas por ENAC.

Con ello, ofrecemos productos no solo estéticamente bonitos y funcionales, sino con el valor de calidad, trazabilidad y seguridad necesarios para entrar en el mercado.

Todos nuestros productos se certifican bajo normativa vigente UNE-EN 1176, y contamos con los certificados de calidad ISO9001, ISO14001, ISO45001 e ISO50001.

Disponer de certificados tanto de producto como de proceso y reciclabilidad, asegura la confianza en todos nuestros productos.

### EN\_

We work directly with independent certification companies accredited by ENAC.

With this, we offer products that are not only aesthetically pleasing and functional, but also carry the value of quality, traceability, and safety required to enter the market.

All our products are certified under the current UNE-EN 1176 standard, and we hold ISO9001, ISO14001, ISO45001, and ISO50001 quality certificates.

Having certifications for both product and process, as well as recyclability, ensures trust in all our products

### FR\_

Nous travaillons directement avec des organismes de certification indépendants accrédités par l'ENAC.

Ainsi, nous proposons des produits non seulement esthétiques et fonctionnels, mais également dotés de la valeur de qualité, de traçabilité et de sécurité nécessaires pour entrer sur le marché.

Tous nos produits sont certifiés conformément à la norme en vigueur UNE-EN 1176, et nous disposons des certifications de qualité ISO9001, ISO14001, ISO45001 et ISO50001.

Disposer de certifications tant pour le produit que pour le processus et la recyclabilité garantit la confiance envers l'ensemble de nos produits

## EMPRESAS CERTIFICADORAS



## NUESTROS CERTIFICADOS

<b>ISO 9001:2015</b>	REGISTRO 203725/A/0001/UK/SP
<b>ISO 14001:2015</b>	REGISTRO 203725/B/0001/UK/En
<b>ISO 45001:2018</b>	REGISTRO ST-351125
<b>ISO 50001:2011</b>	REGISTRO GE-351125
<b>EN 15343:2007</b>	URS/INS/QSG/3747 ( HDPE - HRC)



# DISEÑAR UN PARQUE?

## CONSEJOS

1

### DISEÑO GLOBAL

A la hora de diseñar una zona de juego, ten en cuenta los principales actores. Por suerte, no todos los niños y niñas son iguales, y sus necesidades y formas de aprendizaje y diversión varían. Incluye elementos inclusivos y adaptados, elementos sensoriales que ayuden a la estimulación y diferencíe claramente las zonas por edades.

Recuerda, todos los niños y niñas son especiales.

2

### NO AHORRES EN SEGURIDAD

La normativa vigente es muy clara y exigente en este aspecto. Aunque todos los juegos de nuestro catálogo están certificados, recomendamos hacer hincapié en la instalación de suelos de seguridad de calidad.

Aunque hay zonas de seguridad de elementos de juego que pueden solaparse, intenta separarlos lo máximo posible. Deja espacio suficiente entre elementos, zonas de paso claras, usa colores y texturas y señaliza al máximo posible todos los detalles.

Ten en cuenta que la seguridad no es un coste, sino una inversión.

3

### EL ENTORNO

Siempre es importante estudiar el entorno. No solo la parte urbana, sino la social. El barrio, el pueblo o ciudad, la gente, los niños y niñas que jugarán en el parque, la evolución social y las referencias históricas siempre son puntos de partida que asegurarán el encaje perfecto del parque.

# 4

## SOSTENIBILIDAD

La necesidad actual de cumplir con estándares de sostenibilidad, ya no por normativas, sino por convicción y ética personal y profesional, nos obliga a tener la consciencia sostenible que hasta hace poco era una quimera.

Ten en cuenta que fabricamos nuestras propias planchas de HDPE y las reciclamos hasta un 100% y fabricamos nuestros propios perfiles de HRC (cáscara de arroz) extruido.

# 5

## ASESORAMIENTO

Las dudas nunca son buenas consejeras, y desde MOSSER siempre os daremos un asesoramiento completo. Desde la creación del proyecto hasta la instalación. Sabemos cual es la mejor opción calidad/precio, el proyecto más llamativo, la opción más novedosa o la que más gusta. Por suerte disponemos de un catálogo muy extenso, y daremos con la solución. Seguro.

# 6

## CONFIANZA

Experiencia amplia y demostrable en el sector, fabricantes de nuestro propio material, calidad de diseño y mecanizado, adaptabilidad de fabricación y servicio, multitud de opciones y empresa nacional.

Somos una empresa cercana, clara y profesional, con plazos cortos de fabricación y con rápida respuesta en reposiciones.

No lo dudes, confía en nosotros.

# HRC

## nuestra mejor opción

Presentamos nuestra opción más ecológica. **COMPAKT - HRC** es un material 100% reciclable fabricado mediante extrusión, con acabado satinado y apariencia similar a la madera.

De gran estabilidad dimensional, permite fabricar elementos y productos con acabado premium, manteniendo el mismo sistema de fabricación.

COMPAK - HRC es un material bajo la **certificación EN-15343:2007**, haciendo de los parques fabricados con este material un producto de gran valor ecológico.

material  
único  
patentado

fabricación  
propia  
mediante  
extrusión

cáscara  
de arroz  
+  
plástico  
reciclado

**100%**  
reciclado  
reciclable

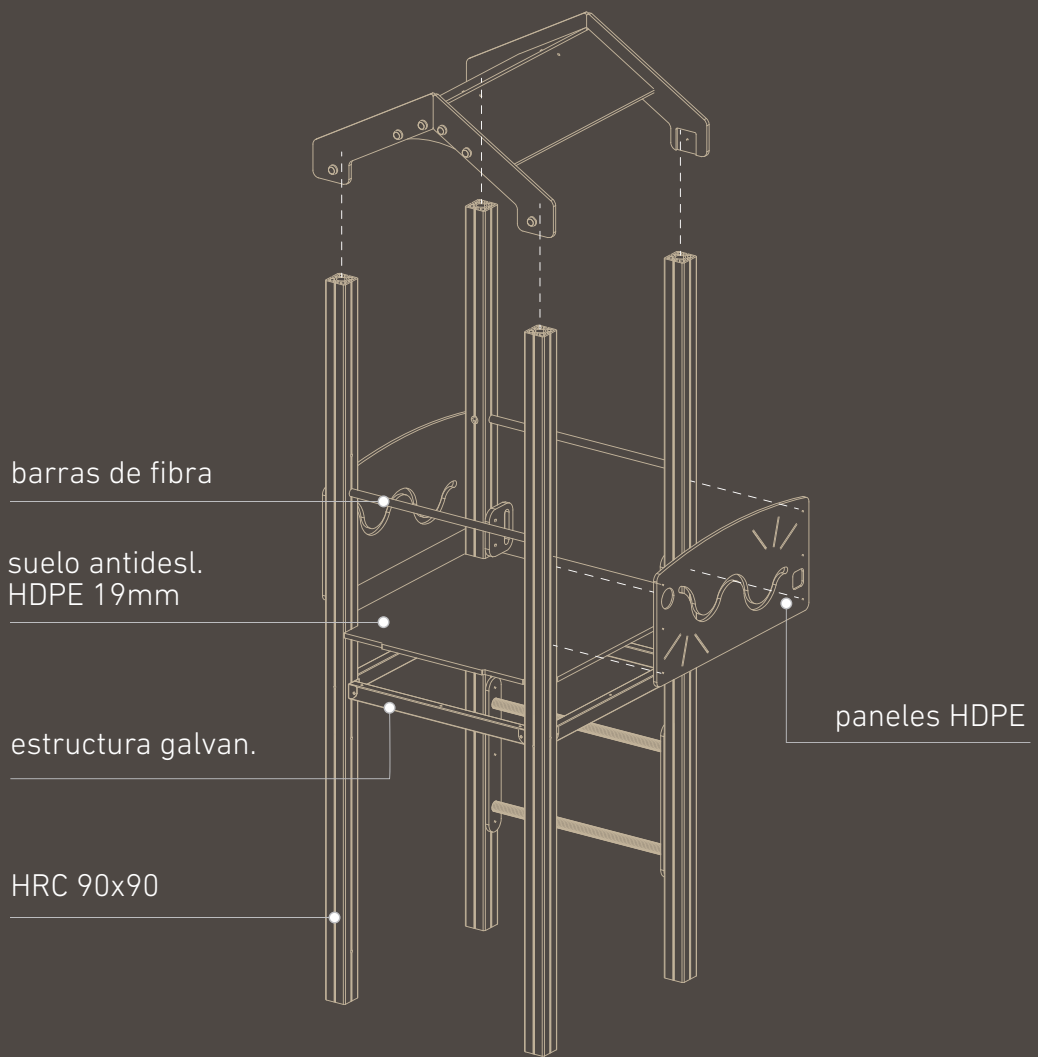

HRC 90x90



HRC 70x70



HRC 110x35

# MATERIALES

## HRC

ES\_

La conciencia medioambiental del consumidor, con una sociedad más sensibilizada en el aprovechamiento de los recursos naturales y la sostenibilidad del ecosistema, ha provocado que el mercado de la madera tienda a la producción de materiales más amigables con el planeta y menos destructivos con la masa forestal.

COMPAKT (Husk Rice Composite) permite todo esto mediante una técnica de producción que no necesita madera, y que utiliza materiales reciclados y reciclables, obteniendo unos resultados igualmente satisfactorios e incluso mucho más creativos.

COMPAKT mezcla cascara de arroz (fibras naturales) con polímeros (plásticos reciclados) para obtener un compuesto con excelentes propiedades estructurales, con más durabilidad y resistencia que la madera tradicional.

EN\_

Consumer environmental awareness, with a more sensitized society in the use of natural resources and ecosystem sustainability, has caused that the wood market tends to produce more friendly materials with the planet and less destructive with the forest mass.

COMPAKT (Husk Rice Composite) allows all this through a production technique that you don't need wood and that uses recycled and recyclable materials, obtaining some equally satisfactory results and even much more creative.

COMPAKT mix rice husk (natural fibers) with polymers (plastics recycled) to obtain a compound with excellent structural properties, with more durability and strength than wood traditional.

FR\_

La sensibilisation environnementale du consommateur, avec une société plus centrée sur l'utilisation des ressources naturelles et à la durabilité de l'écosystème, a provoqué que le marché du bois se dirige vers la production de matériel plus durable, écologique, moins impactant sur la planète et le phénomène de réduction de forêt.

COMPAKT (Husk Rice Composite) permet cela par une technique de production sans bois, utilisant des matériaux recyclés et recyclables, obtenant des résultats tout aussi satisfaisants et même plus créatives.

COMPAKT mélange de coquilles de riz (fibres naturelles) avec du polymère (plastiques recyclés) pour obtenir un composant avec d'excellentes propriétés structurales, plus durable et plus résistant que le bois traditionnel.



### POSTES Y LAMAS DE HRC

90x90mm  
70x70mm  
110x35mm





# VENTAJAS HRC vs MADERA

## MANTENIMIENTO SENCILLO.

EASY MAINTENANCE.  
ENTRETIEN SIMPLE

-  
No necesita barnizado, tintado, aceites, ceras o saturadores.  
Con una limpieza periódica con agua es suficiente.

## MAYOR RESISTENCIA Y DURABILIDAD.

INCREASED STRENGTH AND DURABILITY  
PLUS GRANDE RÉSISTANCE ET DURABILITÉ

-  
Este material responde de manera perfecta al contacto con el entorno y climatología extrema. Además los polímeros ofrece al material una mayor resistencia.

## MENOR ABSORCIÓN DE HUMEDAD.

LESS MOISTURE ABSORPTION  
MOINS D'ABSORPTION D'HUMIDITÉ

-  
Al NO contar con madera no absorbe humedad lo que permite mejor superficie de fricción, mejor resistencia a la lluvia y rayos UVA, y mejor superficie antideslizante.

## POLIVALENCIA.

POLYVALENCE  
POLYVALENCE

-  
Se puede construir en multitud de formatos y colores, permite adaptarse a cualquier espacio y permanece impecable durante años.

## IDEALES PARA EXTERIORES.

IDEAL FOR OUTDOORS.  
IDÉAL POUR L'EXTÉRIEUR.

-  
Por su composición el ofrece unas características que lo convierte en materiales idóneos para su uso en zonas exteriores, ya que resisten muy bien la climatología adversa. También es resistente a lacarcoma, las termitas o el moho. De este modo, suele utilizarse mucho en tarimas de exterior, suelos para terrazas, jardines, alrededores de piscinas o fachadas.

## ESTABILIDAD.

STABILITÉ.  
STABILITY.

-  
Al variar la temperatura este tipo de materiales sufren una dilatación y compresión contenidas y reguladas.

## NO ES ATACADO POR TERMITAS O MICROORGANISMOS.

IT IS NOT ATTACKED BY TERMITES OR MICROORGANISMS  
INSENSIBLE AUX MICRO-ORGANISMES

## NO HAY ASTILLAS NI GRIETAS.

THERE ARE NO SPLINTERS OR CRACKS.  
PAS D'ÉCLATS NI DE FISSURES.

-  
Menos riesgos al caminar.

## INSTALACIONES SENCILLAS Y RAPIDAS.

SIMPLE AND FAST INSTALLATION  
INSTALLATIONS SIMPLÉS ET RAPIDES

## MATERIAL ECO-FRIENDLY.

ECO-FRIENDLY MATERIAL  
MATÉRIAU « ÉCO-FRIENDLY »

-  
Ayuda al medio ambiente al utilizar productos reciclados para su fabricación. Además, también puede reciclarse.

## ECOSOSTENIBLE.

ECO-SUSTAINABLE  
ECO-DURABLE

-  
El material requiere un escaso consumo energético y utiliza residuos naturales que provienen de otras elaboraciones.

## LIGERO.

LIGHT  
LÉGER

-  
Gracias a la utilización de los materiales expandidos es más ligero, esto se traduce en una mayor facilidad de aplicación y de transporte y en una drástica reducción de los costes logísticos.

## (HRC) APARIENCIA A MADERA.

(HRC) WOODEN APPEARANCE  
(HRC) ASPECT BOIS

-  
Posee la misma calidez y naturalidad de la madera real gracias a que tiene la misma apariencia estética de madera.

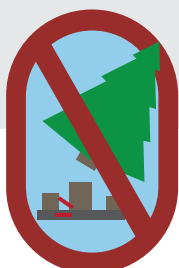

100% RECICLABLE  
100% RECYCLABLE



# MATERIALES

## MADERA



### ES\_

La madera es un material respetuoso con el medio ambiente, una materia prima renovable cuyo aprovechamiento sostenible beneficia al medio ambiente y a la sociedad.

De manera casi imperceptible, la madera nos rodea en nuestras vidas. Es un material sano y agradable que mantiene las condiciones térmicas en las viviendas, modera las fluctuaciones de humedad, purifica el aire y proporciona calidad de vida.

Además, sus características principales son:

- Reciclable: El ciclo de vida de la madera es cerrado. Tras el final de su vida útil, los restos de madera pueden introducirse de nuevo como materia prima para otras industrias de la madera.
- Contribuye a mitigar el cambio climático, almacenando el dióxido de carbono durante todo el ciclo de vida de los productos de madera.
- No emplea apenas energía en su elaboración. El consumo de energía en el proceso de transformación es muy inferior a la utilizada en los de otros materiales de construcción.
- Ofrece soluciones que permiten diseños innovadores. La tecnología ha permitido el desarrollo de numerosos productos derivados de la madera que ofrecen innumerables posibilidades en su uso en construcción.
- Buen comportamiento ante el fuego.

Usamos en la mayoría de productos madera laminada. Contamos además con los recursos necesarios para su tratamiento y mecanizado.

### EN\_

Wood is an environmentally friendly material, a renewable raw material whose sustainable use benefits the environment and society.

Almost imperceptibly, wood surrounds us in our lives. It's a healthy material and pleasant that maintains the thermal conditions in the houses, moderates the fluctuations of moisture, purifies the air and provides quality of life.

In addition, its main features are:

- Recyclable: The wood life cycle is closed. After the end of its useful life, the wood scraps can be introduced again as raw material for others wood industries.
- Contributes to mitigate climate change, storing carbon dioxide during the whole life cycle of wood products.
- Barely uses energy in its elaboration. Energy consumption in the process of transformation is much lower than that used in other construction materials.
- Offers solutions that allow innovative designs. Technology has allowed the development of numerous wood products that offer countless possibilities for its use in construction.
- Good behaviour against fire.

We use laminated wood in most products. We also have the resources necessary for its treatment and machining.

### FR\_

Le bois est un matériau respectueux de l'environnement, une matière première renouvelable dont l'utilisation durable profite à l'environnement et à la société.

Presque imperceptiblement, le bois fait partie de nos vies. C'est un matériau sain et agréable qui maintient les conditions thermiques dans les maisons, modère les fluctuations d'humidité, purifie l'air et offre une excellente qualité de vie.

De plus, ses principales caractéristiques sont:

- Recyclable : le cycle de vie du bois est complet. Après la fin de sa vie utile, les restes de bois peuvent être réutilisés comme matière première pour d'autres industries du bois.
- Il contribue à atténuer le changement climatique, en stockant du dioxyde de carbone tout au long du cycle de vie des produits en bois.
- Il utilise peu d'énergie pour son élaboration. La consommation d'énergie dans le processus de transformation est beaucoup plus faible que celle utilisée dans d'autres matériaux de construction.
- Il propose des solutions qui permettent des conceptions innovantes. La technologie a permis le développement de nombreux produits dérivés du bois qui offrent d'innombrables possibilités dans leur utilisation pour la construction.
- Il a un bon comportement face au feu.

Nous utilisons dans la plupart de nos produits du bois lamellé. Nous avons également les ressources nécessaires pour le traitement et l'usinage.

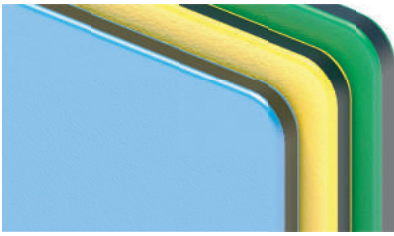

# MATERIALES

## HDPE

### ES\_

El polietileno de alta densidad es un material plástico fabricado por extrusión y suministrado, en este caso, en planchas de varios grosores. Estas planchas llevan el pigmento de color incluido en su proceso de fabricación, lo que asegura una homogeneidad de color a lo largo de su espesor.

Debido a sus numerosas ventajas y a su facilidad de mecanización, este material se ha convertido en un material imprescindible.

Características principales:

- Irrompible: una de las virtudes más destacables es la capacidad de absorción de golpes y elasticidad que tiene. Antes de romperse, el polietileno se deforma, teniendo memoria y recuperando su forma inicial.
- Seguro: incluso en los momentos de rotura, sea por un esfuerzo mecánico superior al estructural o por fatiga, el polietileno no genera aristas cortantes, como sí puede ser el caso de otros materiales (tableros marinos, HPL...).
- Ralladuras: en el polietileno se ven del mismo color que el material, ya que es homogéneo de fuera a dentro. Además, al ser un material plástico, tiene la capacidad de "absorberlos", disimulándolos hasta un 30%.
- Rayos ultravioletas: Algunos polietilenos llevan filtro UVA en la mezcla de fabricación, por lo que la resistencia a los rayos UVA es muy alta.
- Anti vandálico: El polietileno de alta densidad es un material no poroso. Eso significa que cualquier pintura usada en él es de fácil limpieza.
- Resistencia mecánica: El corte por esfuerzo mecánico del polietileno se produce con más del 400% del esfuerzo necesario para romper el HPL.
- Seguridad ante el fuego: No transmite el fuego y es muy difícil que arda. El polietileno, en contacto con el fuego, se deforma y se quema, pero no transmite las llamas.
- Mantenimiento: en condiciones normales no requieren mantenimiento.
- Reciclaje: el material fabricado se muele para su uso en nuevas planchas, aprovechando hasta el 100% del material.

### EN\_

High density polyethylene is a plastic material manufactured by extrusion and supplied, in this case, in sheets of various thicknesses. These sheets carry the color pigment included in its manufacturing process, which ensures homogeneity of color throughout of its thickness.

Due to its numerous advantages and ease of machining, this material has been become an essential material.

Main features:

- Unbreakable: one of the most remarkable virtues is the ability to absorb shock and elasticity of high density polyethylene. Before breaking, the polyethylene is warps, having memory and recovering its initial form.
- Safe: even in times of breakage, whether due to a mechanical effort greater than structural or fatigue, polyethylene does not generate sharp edges, as it can be the case of other materials (marine boards, HPL...).
- Scratches: on the polyethylene look the same colors as the material, since it's homogeneous from outside to inside. In addition, being a plastic material, it has the ability to "absorb them", hiding them up to 30%.
- Ultraviolet rays: Some polyethylene carry UVA filter in the manufacturing mix, by what the resistance to UVA is very high.
- Anti-vandal: High density polyethylene is a non-porous material. That means any paint used on it is easy to clean.
- Mechanical resistance: The mechanical stress cutting of polyethylene is produced with more than 400% of the effort needed to break the HPL.
- Fire safety: It does not transmit fire and it is very difficult to burn. Polyethylene, in contact with fire, deforms and burns, but does not transmit flames.
- Maintenance: under normal conditions the HDPE does not require maintenance, which means a great advantage and resource savings.
- Recycling: the manufactured material is ground for use in new sheets, using up to 100% of the material.

### FR\_

Le polyéthylène haute densité est un matériau plastique fabriqué par extrusion et fourni, dans ce cas, par feuilles de différentes épaisseurs. Ces plaques intègrent le pigment de couleur dans leur processus de fabrication, ce qui assure une homogénéité de la couleur sur toute son épaisseur.

De par ses nombreux avantages et sa facilité de mécanisation, ce matériau est devenu un matériau incontournable.

Principales caractéristiques :

- Incassable: l'une des vertus les plus remarquables est la capacité d'absorption des chocs et l'élasticité du polyéthylène haute densité. Avant de se casser, le polyéthylène se déforme, ayant de la mémoire et retrouvant sa forme initiale.
- Sûr: même en cas de casse, qu'elle soit due à des contraintes mécaniques supérieures aux contraintes structurales ou à la fatigue, le polyéthylène ne génère pas d'arêtes vives, comme cela peut être le cas avec d'autres matériaux (contreplaqué, HPL ...).
- Rayures: comme il s'agit de polyéthylène, elles ont la même couleur que le matériau, car ce dernier est homogène de l'extérieur vers l'intérieur. De plus, étant un matériau plastique, il a la capacité de les «absorber», les cachant jusqu'à 30%.
- Rayons ultraviolets: Certains polyéthylènes ont un filtre UV dans le mélange de fabrication, donc la résistance aux UV est très élevée.
- Anti vandalisme: le polyéthylène haute densité est un matériau non poreux. Cela signifie que toute peinture utilisée est facile à nettoyer.
- Résistance mécanique: La découpe sous contrainte mécanique du polyéthylène est réalisée avec plus de 400% de l'effort requis pour casser le HPL.
- Sécurité incendie: il ne transmet pas le feu et il est très difficile à brûler. Le polyéthylène, au contact du feu, se déforme et brûle, mais ne transmet pas de flammes.
- Maintenance: dans des conditions normales, il ne nécessite pas de maintenance, représentant un grand avantage et des économies d'entretiens.
- Recyclage : le matériau fabriqué est broyé pour être utilisé dans de nouvelles plaques, en utilisant jusqu'à 100 % du matériau.

# MATERIALES

## ALUMINIO

ES\_

Disponer de un material con un acabado de alta calidad, ligero, preciso y reciclable hasta un 95% aumenta las opciones y prestaciones de nuestro catálogo.

Fabricamos nuestro perfil mediante extrusión, usando una aleación 6060 con temple T6 y acabado anodizado.

El aluminio, material ligero frente a otros metales usados en construcción, permite su fabricación con acabado anodizado, aumentando su resistencia a la corrosión y mejorando de forma notable su acabado, haciéndolo un material perfecto para instalaciones en exteriores.

Al ser un material 95% reaprovechable permite ofrecer una opción ecológica y sostenible frente a otras opciones metálicas, siendo una gran opción para proyectos de economía circular.

EN\_

Including a material with a high-quality finish, lightweight, precise, and 95% recyclable increases the options and features of our catalog.

Our profile is made through extrusion process in a 6060 alloy with T6 temper and anodized finish.

Aluminum, a lightweight material compared to other metals used in construction, increases its corrosion resistance and significantly improves its appearance due to anodized finish, making it a perfect material for outdoor installations.

Being a 95% reusable material allows us to offer an ecological and sustainable option compared to other metallic options, making it a great choice for circular economy projects.

FR\_

Disposer d'un matériau avec une finition de haute qualité, léger, précis et 95% recyclable augmente les options et les performances de notre catalogue.

Nous fabriquons notre profilé par extrusion, en utilisant un alliage 6060 avec un traitement thermique T6 et une finition anodisée.

L'aluminium, matériau plus léger que d'autres métaux utilisés dans la construction, permet une finition anodisée, ce qui augmente sa résistance à la corrosion et améliore considérablement son apparence, en faisant un matériau idéal pour les installations extérieures.

Étant un matériau 95% reusable, il constitue une option écologique et durable face à d'autres alternatives métalliques, ce qui en fait un excellent choix pour les projets d'économie circulaire.

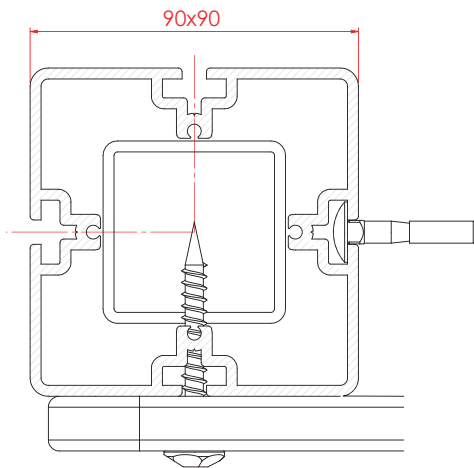

# MATERIALES

## METALES

### ES\_

Inoxidable, negro, galvanizado o zincado. Usamos todo tipo de acero según el producto y las necesidades. Contamos con los recursos adecuados para el transformado y soldado de cualquiera de ellos.

#### **Acero negro\_**

usado en los modelos más complejos o en chapas de grosores especiales, anclajes o herrajes estructurales, para su posterior tratamiento como conjunto soldado. Aún terminando con un lacado o pintura al horno, nos gusta zincarlo o galvanizarlo.

#### **Acero galvanizado\_**

usado principalmente en herrajes plegados o chapas planas.

#### **Acero inoxidable\_**

usando calidades desde AISI-304 a AISI-16, somos partidarios de presentarlo con acabado satinado.

### EN\_

Stainless, black, galvanized or zinc plated. We use all types of steel according to the product and the needs. We have adequate resources for the transformation and welding of any of them.

#### **Raw steel\_**

used in more complex models or in special thickness plates, as anchors or structural fittings, for later treatment as a whole soldier. Even finishing with a lacquered or baked paint, we like to coat it with zinc or galvanize it

#### **Galvanized steel\_**

mainly used in folded fittings or flat sheets.

#### **Stainless steel\_**

using qualities from AISI-304 to AISI-16, we support present it with satin finish.

### FR\_

Inox, noir, galvanisé ou zingué. Nous utilisons tous les types d'acier selon le produit et les besoins. Nous avons des moyens adaptés pour la transformation et le soudage de chacun d'entre eux.

#### **Acier noir\_**

utilisé dans les modèles les plus complexes ou dans des plaques d'épaisseur spéciale, telles que des ancrages ou des raccords structurels, pour un traitement ultérieur en tant qu'ensemble soudé. Même en finissant avec une peinture laquée ou cuite, nous aimons le zinguer ou le galvaniser.

#### **Acier galvanisé\_**

principalement utilisé dans les raccords pliés ou les tôles plates.

#### **Acier inoxydable\_**

en utilisant les qualités de l'AISI-304 à l'AISI-16, nous sommes favorables à sa présentation en finition satinée.



## ANTIDESLIZANTES

### ES\_

Disponemos de dos opciones de tableros antideslizantes, todas ellas de gran calidad y aptas para su uso tanto como suelo como en asientos y peldaños.

#### **Contrachapado antideslizante\_**

opción de tablero de madera con lámina superior antideslizante. Es un material de gran resistencia y estabilidad dimensional, disponible con dibujo hexagonal. Necesita de un barniz en todas sus aristas para asegurar la durabilidad en exteriores.

#### **Panel HDPE 19mm\_**

Fabricado tanto en negro monocolor como gris bicolor, este material cuenta con una gran durabilidad exterior, manteniendo todas las características y ventajas del HDPE.

A parte de su reciclabilidad, permite agilizar tiempos y procesos de fabricación, además de ser un material fabricado en nuestras instalaciones.

### EN\_

We have two options for non-slip boards, all of them of high quality and suitable for use both as flooring and in seats and steps.

#### **Non-slip plywood panel\_**

a wooden board option with a non-slip top layer. It is a material of great strength and dimensional stability, available with a hexagonal design. It requires varnishing on all its edges to ensure durability outdoors.

#### **19mm HDPE Panel\_**

Manufactured in both solid black and bi-color grey, this material has great outdoor durability, maintaining all the characteristics and benefits of HDPE. In addition to its recyclability, it streamlines manufacturing times and processes, and it is a material produced at our facilities.

### FR\_

Nous avons deux options de panneaux antidérapants, tous de grande qualité et adaptés à une utilisation aussi bien pour le sol que pour les sièges et les marches.

#### **Contreplaqué antidérapant\_**

option de panneau en bois avec une surface supérieure antidérapante. C'est un matériau de grande résistance et de stabilité dimensionnelle, disponible avec un motif hexagonal. Il nécessite un vernis sur toutes ses arêtes pour garantir la durabilité en extérieur. Panneau

#### **HDPE 19 mm\_**

Fabriqué en noir monochrome et en gris bicolore, ce matériau présente une grande durabilité extérieure, conservant toutes les caractéristiques et avantages du HDPE.

En plus de sa recyclabilité, il permet d'accélérer les temps et les processus de fabrication, tout en étant un matériau fabriqué dans nos installations.



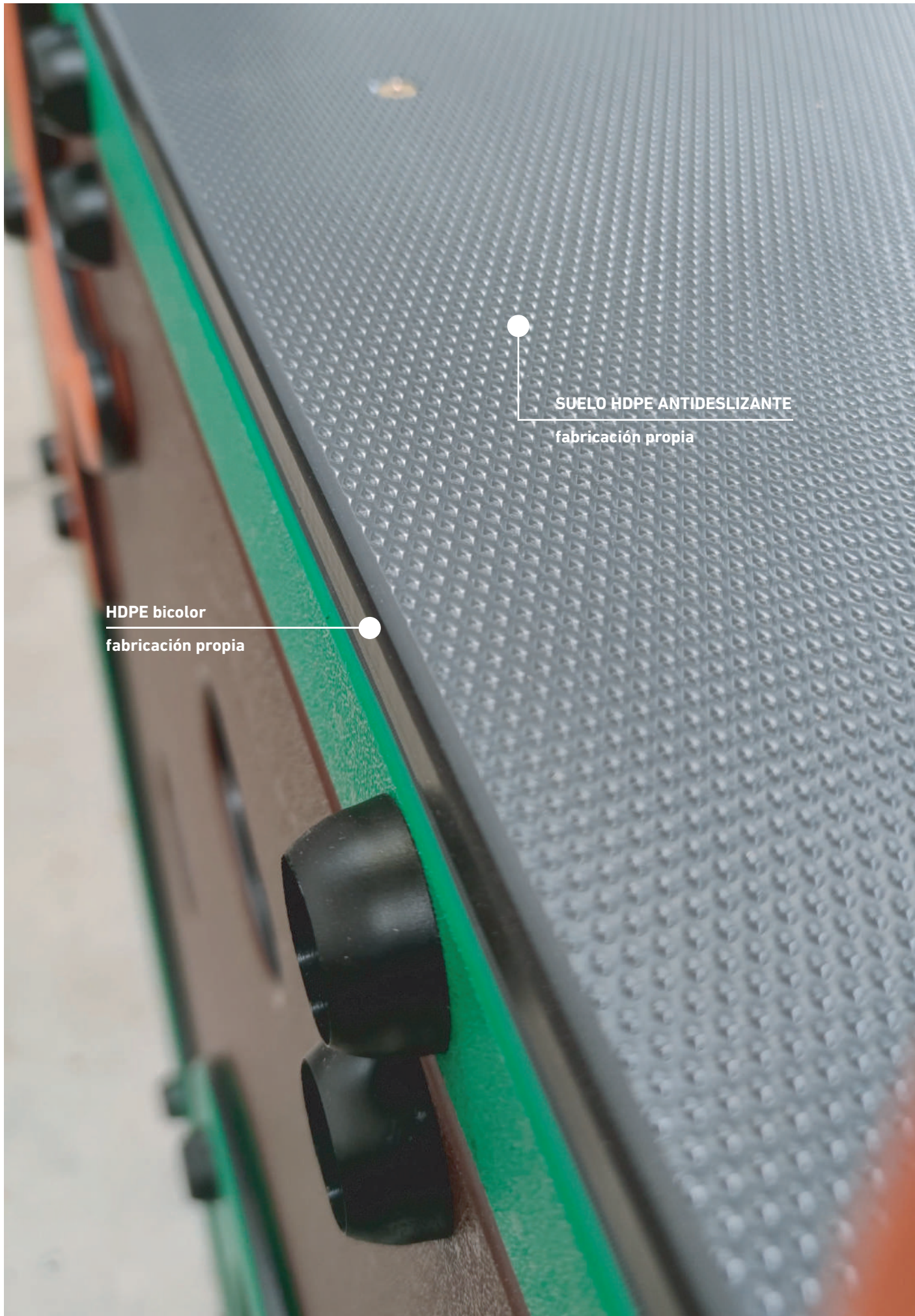

SUELO HDPE ANTIDESLIZANTE

fabricación propia

HDPE bicolor

fabricación propia

# OPCIONES

## ESTRUCTURA

Los distintos elementos de juego del catálogo disponen de la posibilidad de elegir el material principal de la estructura. Esta posibilidad permite la adaptación o personalización del elemento elegido, ajustándose a las necesidades de cada proyecto.

Cada elemento tiene la indicación de los materiales disponibles.

### **M** **MDR** **MADERA**

Madera de pino laminada tratada en autoclave, de sección 90x90, barnizada con lasour al agua color caoba aplicado mediante pistola.



### **H** **HRC** **MADERA TÉCNICA COMPAKT**

Perfil extrusionado de cáscara de arroz, de secciones 90x90 y 70x70, con acabado semi mate



**G GLV ACERO GALVANIZADO**

Perfil metálico 90x90x2 y 90x90x3 galvanizado



**AL ALUMINIO**

Perfil de aluminio extrusionado de 90x90, calidad 6060-T6 con acabado anodizado plata.



**INOX ACERO INOXIDABLE**

Perfil de acero inoxidable AISI304 de varias secciones, con soldadura TIG.

Posibilidad de AISI3016 bajo pedido y condiciones particulares.



**LAC ACERO TERMOLACADO**

Perfiles metálicos tubulares usados en vallas metálicas, con capa de imprimación y termolacado.





**playfor**



## **IMPORTANTE**

**Los productos del catálogo están sujetos a modificaciones sin previo aviso.**  
Catalog products are subject to modifications without prior notice.

**Las imágenes de juegos mostradas en el catálogo son en su mayoría 3D, no teniendo ningún valor contractual.**  
The game images shown in this brochure are mostly 3D, having no contractual value.

# ÍNDICE

## CATÁLOGO INTERACTIVO

puede ir directamente a cada una de las series cliqueando sobre la flecha. Para volver al índice, cliquee sobre los rectángulos de colores en el lateral de la página. De la misma manera, puede descargar la ficha técnica de cada elemento cliqueando sobre el icono-flecha de cada elemento.

PEQUEÑOS  
**MOSSY**



PEQUEÑOS  
**FRUTAS**



PEQUEÑOS  
**NOMOS**



PEQUEÑOS / INCL.  
**MINIM**



MAYORES  
**BASIC**



MAYORES  
**ARGOS**



PEQUEÑOS / MAYORES  
**NU20**



MAYORES  
**SUN**



MAYORES  
**TORNADUS**



PEQUEÑOS / MAYORES  
**JUEGA**



INOXIDABLE  
**PANGEA**



INOXIDABLE  
**ESPACIO**



INOXIDABLE  
**LUXURY**



INOXIDABLE / INCL.  
**MEC-AND**



INCLUSIVO  
**TLN**



TEMÁTICO  
**BOSQUE**



TEMÁTICO  
**ÁRBOL**



TEMÁTICO  
**CASTILLOS**



TEMÁTICO  
**VINÍCOLA**



TEMÁTICO  
**MEDIEVO**



TEMÁTICO  
**PIRATAS**



TEMÁTICO  
**DINOSAURIOS**



TEMÁTICO  
**ANIMALES**



TEMÁTICO  
**AVIONES**



TEMÁTICO  
**BARCOS**



TEMÁTICO  
**PINTA**



TEMÁTICO  
**SELVA**



TEMÁTICO  
**CUBIC**



TEMÁTICO  
**GIGANTES**



INDEPENDIENTE  
**REDES**



INDEPENDIENTE  
**TIROLINAS**



INDEPENDIENTE  
**TRENES**



INDEPENDIENTE  
**CASITAS**



INDEPENDIENTE  
**TOBOGANES**



INDEPENDIENTE / INCL.  
**COLUMBIOS**



INDEPENDIENTE / INCL.  
**MUELLES**



INDEPENDIENTE / INCL.  
**CARRUSELES**



ACCESORIOS  
**COMPLEM.**



ACCESORIOS  
**CAMA ELAST.**

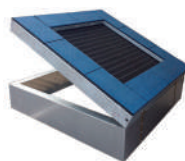

ACCESORIOS  
**PANELES**



ACCESORIOS  
**VALLAS**

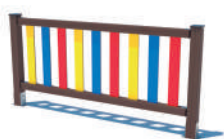

ACCESORIOS  
**CARTELES**



ACCESORIOS  
**MESAS**



ACCESORIOS  
**SUELOS**



EJERCICIO  
**DEPORTIVO**



EJERCICIO  
**STREETWORK**



MAYORES  
**PARKOUR**



MAYORES  
**BIOPARQUES**



MAYORES  
**EN FORMA**



EJERCICIO  
**MULTIDEP.**

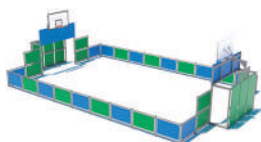

**VELAS**



**SOMBRAS**



**AGILITY**



EJERCICIO  
**SKATE**



## LEYENDA

Vista de producto 

Nombre producto **NOMBRE**  Indicación juego accesible

Código producto PLF-000

Edad de uso **1a12** **DIM** -- m Dimensiones máx.

Altura de caída  -- m **ZS** -- m Zona seguridad máx.

Usuarios  -- u. **M H G AL** Opciones material estructura

## CODIFICACIÓN

Los códigos indicados en el catálogo son los códigos genéricos con estructura de madera. En caso de necesitar el juego con estructura de otro material, hay que indicarlo con el sufijo pertinente. Cada juego tiene indicadas las posibilidades de estructura.

PLF-000	juego en madera
PLF-000- <b>M</b>	juego metálico (galvanizado)
PLF-000- <b>H</b>	juego en HRC
PLF-000- <b>A</b>	juego en aluminio



# MOSSY



## CASITA

MOS-001

1a5

↓ <0,6m

⌚ 8 u.

**DIM** 2,75 x 2,27m

**ZS** 5,75 x 5,27m

**M** **H** **G** **AL**



## MOSSY 02

MOS-002

1a5

↓ 0,9m

⌚ 5 u.

**DIM** 3,27 x 2,34m

**ZS** 5,34 x 5,70m

**M** **H** **G** **AL**



## MOSSY 03

MOS-003

1a5

**DIM** 4,02 x 2,83m

↓ 0,9m

**ZS** 6,53 x 5,31m

☺ 12 u.

**M H G AL**



## MOSSY 04

MOS-004

1a5

**DIM** 5,85 x 3,80m

↓ 0,9m

**ZS** 8,36 x 6,21m

☺ 6 u.

**M H G AL**



## MOSSY 05

MOS-005

1a5

**DIM** 3,65 x 3,65m

↓ 0,9m

**ZS** 6,65 x 6,30m

☺ 10 u.

**M H G AL**



## MOSSY 06

MOS-006

1a5

**DIM** 1,03 x 4,4m

↓ 0,9m

**ZS** 7,76 x 6,68m

☺ 8 u.

**INOX**



## PUNK

BAL-036



1a5 <0,6m 1u.

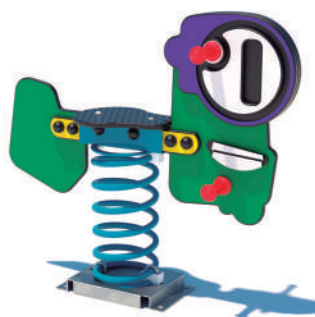

## FLEQUI

BAL-037



1a5 <0,6m 1u.



## ROCK

BAL-038



1a5 <0,6m 1u.

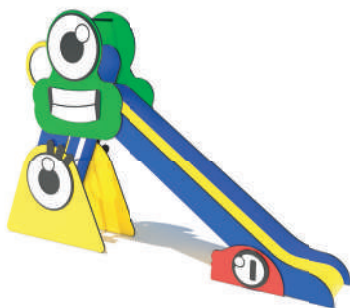

## TOBOGÁN

TOB-008



1a5 0,9m 2u.

**DIM** 2,63 x 0,55m

**ZS** 5,13 x 3,55m

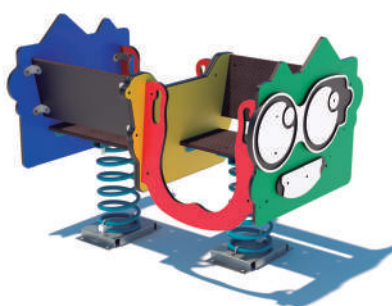

## INCLUSIVO

BAL-053



3a12 <0,6m 2u.

**DIM** 1,25 x 0,90m

**ZS** 3,64 x 3,07m

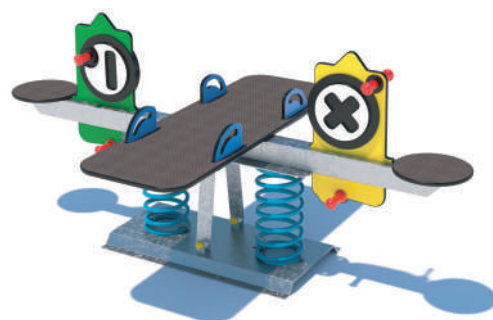

## BALANCIN 4P

BAL-052



3a12 <0,6m 2u.

**DIM** 2,14 x 1,36m

**ZS** 4,14 x 4,35m



## HAPPY

BAL-039



1a5 <0,6m 2u.



## COLUMPIO

COL-016 DOBLE / COL-016B MIXTO



3a12 1,34m 2u. **M** **H** **G**



TEJADO PERFORADO

OJOS SOBREDIMENSIONADOS

BANCO

OJO ROTACIONAL

TÚNEL ACCESIBLE



# FRUTAS



## FRUTAS 01

FRU-001

1a5

↓ 0,9m

☺ 4u.

**DIM** 3,46 x 0,88m

**ZS** 5,96 x 3,84m

**M** **H** **G** **AL**



## FRUTAS 02

FRU-002

1a5

↓ 0,9m

☺ 5u.

**DIM** 3,68 x 3,46m

**ZS** 5,96 x 5,16m

**M** **H** **G** **AL**



### FRUTAS 03

FRU-003

1a5

**DIM** 3,46 x 2,73m

↓ 0,9m

**ZS** 5,96 x 5,71m

☺ 6u.

**M H G AL**



### FRUTAS 04

FRU-004

1a5

**DIM** 5,53 x 3,46m

↓ 0,9m

**ZS** 5,96 x 7,03m

☺ 6u.

**M H G AL**



### FRUTAS 05

FRU-005

1a5

**DIM** 3,03 x 3,46m

↓ 0,9m

**ZS** 5,96 x 5,94m

☺ 10u.

**M H G AL**



### FRUTAS 06

FRU-006

1a5

**DIM** 3,60 x 5,96m

↓ 0,9m

**ZS** 8,46 x 6,50m

☺ 12u.

**M H G AL**



## CASITA

FRU-007

1a5

**DIM** 1,35 x 1,81m

↓ <0,6m

**ZS** 3,33 x 3,75m

☺ 4u.

**M H G AL**



## COLUMPIO MIXTO

FRU-008

1a5

**DIM** 3,93 x 1,67m

↓ 1,34m

**ZS** 7,00 x 4,00m

☺ 2u.

**M H G AL**



## TOBOGÁN

FRU-009

3a12 ↓ 0,9m ☺ 2u.

**DIM** 3,03 x 0,46m

**ZS** 4,78 x 3,58m

**INOX**

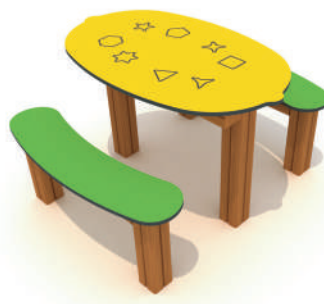

## MESA LIMÓN

FRU-010

1a5 ↓ <0,6m ☺ 6u.

**DIM** 1,15 x 1,00m

**ZS** 4,15 x 3,40m

**M H G**



## MESA PLÁTANO

FRU-010A

1a5 ↓ <0,6m ☺ 6u.

**DIM** 1,19 x 1,03m

**ZS** 4,19 x 4,03m

**M H G**



## PROYECTO PARQUE FRUTAS

FRU-006 3 TORRES

FRU-007 CASITA

FRU-008 COLUMPIO MIXTO

BAL-026 MUELLE NARANJA



## NOMOS 01

NOM-001



**1a5**



<0,6m



4u.

**DIM**

1,02 x 1,03m

**ZS**

4,14 x 4,03m

**MDR**

**HRC**

**GLV**



## NOMOS 02

NOM-002



**1a5**



0,9m



5u.

**DIM**

1,02 x 2,70m

**ZS**

5,23 x 4,04m

**MDR**

**HRC**

**GLV**



## NOMOS 03B

NOM-003B



1a5

**DIM** 2,36 x 2,95m

<0,6m

**ZS** 5,74 x 5,21m

5u.

**MDR** **HRC** **GLV**



## NOMOS 04

NOM-004



1a5

**DIM** 3,81 x 2,73m

<0,6m

**ZS** 6,82 x 5,23m

8u.

**MDR** **HRC** **GLV**



## NOMOS 05

NOM-005



1a5

**DIM** 3,92 x 2,73m

<0,6m

**ZS** 6,82 x 5,23m

10u.

**MDR** **HRC** **GLV**



## NOMOS 06

NOM-006



1a5

**DIM** 1,03 x 1,04m

<0,6m

**ZS** 4,03 x 4,04m

4u.

**MDR** **HRC** **GLV**



# MINiM



## MINIM 01

MIN-001



1a5

↓ 0,9m

⌚ 6u.

**DIM** 3,36 x 1,87m

**ZS** 5,80 x 4,75m

**MDR** **HRC** **GLV**



## MINIM 02

MIN-002



1a5

↓ 0,9m

⌚ 10u.

**DIM** 4,76 x 3,63m

**ZS** 7,68 x 6,04m

**MDR** **HRC** **GLV**



### MINIM 03

MIN-003



**1a5**

**DIM** 4,04 x 6,80m

0,9m

**ZS** 9,20 x 6,90m

15u.

**MDR** **HRC** **GLV**



### MINIM 04

MIN-004



**1a12**

**DIM** 4,65 x 4,89m

<0,6m

**ZS** 7,65 x 7,82m

10u.

**MDR** **HRC** **GLV**



### MINIM 04A

MIN-004A



**1a12**

**DIM** 4,65 x 4,89m

<0,6m

**ZS** 7,65 x 8,15m

10u.

**MDR** **HRC** **GLV**



### MINIM 05

MIN-005



**1a12**

**DIM** 7,15 x 4,89m

<0,6m

**ZS** 10,15 x 7,82m

15u.

**MDR** **HRC** **GLV**



## MINIM 05A

MIN-005A



**1a5**

**DIM** 7,15 x 4,89m

**↓** <0,6m

**ZS** 10,15 x 8,15m

**☉** 15u.

**MDR HRC GLV**



## MINIM 06

MIN-006



**1a12**

**DIM** 7,14 x 5,79m

**↓** <0,6m

**ZS** 10,15 x 8,27m

**☉** 17u.

**MDR HRC GLV**



## MINIM PLUS 01

MIN-011



3a12

**DIM** 3,06 x 4,55m

1,3m

**ZS** 6,55 x 6,01m

8u.

**MDR** **HRC** **GLV**



## MINIM PLUS 02

MIN-012



3a12

**DIM** 6,53 x 3,45m

1,3m

**ZS** 9,00 x 6,39m

10u.

**MDR** **HRC** **GLV**

## MINIMPLUS 03

MIN-013



3a12

**DIM** 3,58 x 7,66m

1,3m

**ZS** 9,37 x 6,50m

15u.

**MDR** **HRC** **GLV**

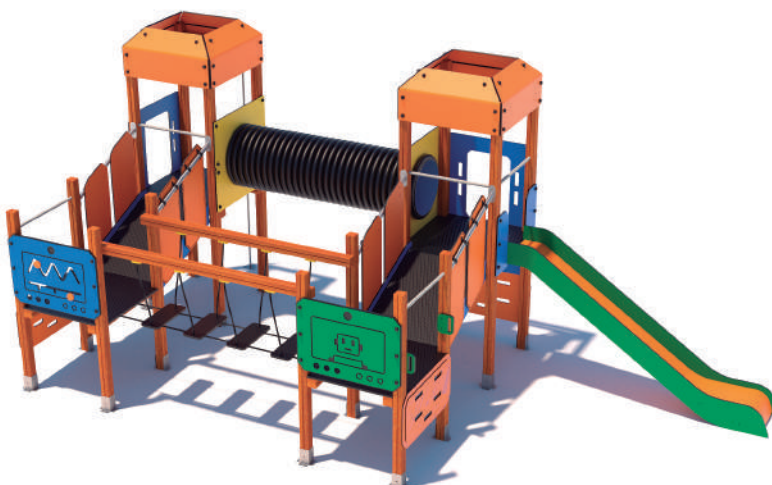



# BASIC



## BASIC 01

BAS-001



**5a12**



1,30m



4u.

**DIM**

1,16 x 3,62m

**ZS**

6,06 x 4,00m

**MDR**

**HRC**

**GLV**



## BASIC 02

BAS-002



**5a12**



1,30m



7u.

**DIM**

3,19 x 3,62m

**ZS**

6,19 x 6,06m

**MDR**

**HRC**

**GLV**



## BASIC 03

BAS-003



**5a12**

**DIM** 4,14 x 3,62m

**↓** 1,30m

**ZS** 5,31 x 7,80m

**☺** 5u.

**MDR** **HRC** **GLV**



## BASIC 04

BAS-004



**5a12**

**DIM** 6,33 x 3,62m

**↓** 1,30m

**ZS** 7,50 x 7,80m

**☺** 8u.

**MDR** **HRC** **GLV**



## BASIC 05

BAS-005



**3a8**

**DIM** 4,16 x 3,62m

**↓** 1,30m

**ZS** 7,03 x 6,06m

**☺** 10 u.

**MDR** **HRC** **GLV**



## BASIC 05B

BAS-005B



**3a8**

**DIM** 4,28 x 5,73m

**↓** 1,30m

**ZS** 7,03 x 8,19m

**☺** 13u.

**MDR** **HRC** **GLV**



## BASIC 06

BAS-006



**3a8**

**DIM** 3,67 x 3,62m

**↓** 1,30m

**ZS** 6,50 x 6,06 m

**☺** 10u.

**MDR** **HRC** **GLV**



## BASIC 06B

BAS-006B



**3a8**

**DIM** 6,41 x 3,62m

**↓** 1,30m

**ZS** 7,95 x 7,05m

**☺** 11u.

**MDR** **HRC** **GLV**



## BASIC 07

BAS-007



**3a8**

**DIM** 6,62 x 3,79m

**↓** 1,30m

**ZS** 9,06 x 6,05m

**☺** 16u.

**MDR** **HRC** **GLV**



## BASIC 7A

BAS-007A



**3a8**

**DIM** 7,20 x 3,62m

**↓** 1,30m

**ZS** 10,16 x 6,02m

**☺** 16u.

**MDR** **HRC** **GLV**



## BASIC 08

BAS-008

3a8

**DIM** 9,25 x 3,50m

↓ 1,30m

**ZS** 11,12 x 6,50 m

☺ 22u.

**MDR** **HRC** **GLV**

## BASIC 009

BAS-009

3a8

**DIM** 9,54 x 9,12m

↓ 1,30m

**ZS** 11,56 x 11,12m

☺ 30u.

**MDR** **HRC** **GLV**



## BASIC 10

BAS-010

3a8

**DIM** 9,29 x 4,61m

↓ 1,30m

**ZS** 11,56 x 7,43m

☺ 25u.

**MDR** **HRC** **GLV**



## BASIC UPGRADE

Mejora cualquier elemento de la serie BASIC con la inclusión de paneles interactivos!

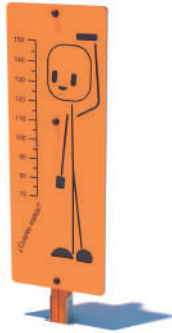

### ALTURA

PIP-001



### TRADUCTOR

PIP-002



### 3 EN FILA

PIP-003



### SOPA LETRAS

PIP-004



### CARRERAS

PIP-005



### CIRCUITO

PIP-006

### EJEMPLO

BAS-001 + PIP-004



BAS-001



BAS-001 + PI-004



# ARGOS



## ARGOS 01

ARG-001

5a12



1,30m



4u.

**DIM**

1,10 x 3,62m

**ZS**

6,06 x 4,00m

**MDR**

**HRC**

**GLV**



## ARGOS 02

ARG-002

5a12



1,30m



7u.

**DIM**

3,27 x 3,62m

**ZS**

6,19 x 6,06m

**MDR**

**HRC**

**GLV**



## ARGOS 03

ARG-003



**5a12**

**DIM** 4,24 x 3,62m

1,30m

**ZS** 5,31 x 7,80m

5u.

**MDR** **HRC** **GLV**



## ARGOS 04

ARG-004



**5a12**

**DIM** 6,43 x 3,62m

1,30m

**ZS** 7,50 x 7,80m

8u.

**MDR** **HRC** **GLV**



## ARGOS 05

ARG-005



**5a12**

**DIM** 4,10 x 3,62m

1,30m

**ZS** 7,03 x 6,06m

10 u.

**MDR** **HRC** **GLV**



## ARGOS 06

ARG-006



**5a12**

**DIM** 3,50 x 3,62m

1,30m

**ZS** 6,50 x 6,06m

10u.

**MDR** **HRC** **GLV**



## ARGOS 07

ARG-007



**5a12**

**DIM** 6,62 x 3,62m

1,30m

**ZS** 9,06 x 6,50m

16u.

**MDR** **HRC** **GLV**



## ARGOS 08

ARG-008



**5a12**

**DIM** 3,53 x 9,25m

1,30m

**ZS** 6,50 x 11,12m

22u.

**MDR** **HRC** **GLV**



## ARGOS 08G

ARG-008G



**5a12**

**DIM** 5,32 x 9,99m

1,30m

**ZS** 7,82 x 12,78m

22u.

**MDR** **HRC** **GLV**



## ARGOS 09

ARG-009

5a12

**DIM** 9,55 x 9,15m

↓ 1,30m

**ZS** 11,12 x 11,56m

⌚ 30u.

**MDR** **HRC** **GLV**



## ARGOS 20

ARG-020

1a12

**DIM** 8,10 x 4,78m

↓ 1,30m

**ZS** 10,63 x 7,78m

⌚ 34u.

**MDR** **HRC** **GLV**

## CASITA ARGOS

ARG-012

1a5

**DIM** 1,73 x 1,36m

**↓** <0,6m

**ZS** 4,67 x 4,36m

**⌚** 4u.

**MDR** **HRC** **GLV**



## CASA 2 PLANTAS

IND-021

3a12

**DIM** 3,82 x 2,71m

**↓** 1,30m

**ZS** 6,22 x 5,66m

**⌚** 16u.

**MDR** **HRC** **GLV**



## PANELES INTERACTIVOS ARGOS EXTRA

La serie ARGOS cuenta con la posibilidad de cambiar paneles interactivos a los distintos juegos de la serie. Consultar características y disponibilidad



**SOPA DE LETRAS**  
PIN-004

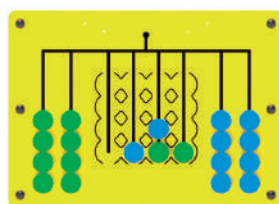

**3 EN RAYA**  
PIN-003



**CARRERAS**  
PIN-005

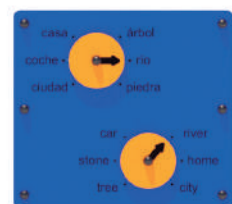

**ESP-ING**  
PIN-002



# NU20



## NU20 01

NU2-001



**1a8**  <0,6m  6u.

**DIM** 1,02x1,21m **ZS** 4x3,95m

**M** **H** **G** **AL**



## NU20 01B

NU2-001B



**1a8**  <0,6m  6u.

**DIM** 2,12x1,95m **ZS** 4,8x4,9m

**M** **H** **G** **AL**



## NU20 02

NU2-002



**1a8**  <0,6m  12u.

**DIM** 1,93 x 1,5m **ZS** 4,9 x 3,7m

**M** **H** **G** **AL**



### NU20 03

NU2-003



**3a8**

**DIM** 3,40 x 1,10m

**↓** 0,90m

**ZS** 5,90 x 4,05m

**☺** 5u.

**M H G AL**



### NU20 04

NU2-004



**3a12**

**DIM** 3,54 x 1,10m

**↓** 1,30m

**ZS** 5,90 x 4,05m

**☺** 5u.

**M H G AL**



### NU20 05

NU2-005



**3a12**

**DIM** 3,54 x 3,10m

**↓** 1,30m

**ZS** 5,90 x 6,02m

**☺** 8 u.

**M H G AL**



### NU20 06

NU2-006



**3a12**

**DIM** 3,54 x 4,90m

**↓** 1,30m

**ZS** 7,72 x 6,37m

**☺** 7u.

**M H G AL**



## NU20 07

NU2-007



**1a12**

**DIM** 3,54 x 6,87m

**↓** 1,30m

**ZS** 8,44 x 7,72m

**☺** 10u.

**M H G AL**



## NU20 08

NU2-008



**1a12**

**DIM** 3,54 x 2,74m

**↓** 1,30m

**ZS** 5,75 x 5,90m

**☺** 7u.

**M H G AL**



## NU20 09

NU2-009



**1a12**

**DIM** 4,25 x 3,54m

**↓** 1,30m

**ZS** 6,60 x 6,54m

**☺** 12u.

**M H G AL**



## NU20 10

NU2-010



**1a12**

**DIM** 6,55 x 3,69m

**↓** 1,30m

**ZS** 8,89 x 6,54m

**☺** 28u.

**M H G AL**

## NU20 11

NU2-011



1a12

**DIM** 3,83 x 3,87m

1,30m

**ZS** 6,88 x 6,28m

12u.

**M** **H** **G** **AL**



## NU20 11A

NU2-011A



1a12

**DIM** 5,51 x 3,83m

1,30m

**ZS** 8,51 x 6,28m

16u.

**M** **H** **G** **AL**

## NU20 12

NU2-012



1a12

**DIM** 3,82 x 5,34m

1,30m

**ZS** 6,88 x 7,84m

19u.

**M** **H** **G** **AL**



## NU20 13

NU2-013



1a12

**DIM** 5,86 x 5,83m

1,30m

**ZS** 8,84 x 8,15m

25u.

**M** **H** **G** **AL**



## NU20 20

NU2-020



5a12

**DIM** 8,54 x 6,08m

1,30m

**ZS** 12,02 x 9,13m

20u.

**MDR** **GLV** **AL**





# SUN



## SUN 01

SUN-001



**5a12**

1,3m

4u.

**DIM** 3,93 x 0,83m

**ZS** 6,32 x 3,80m

**MDR** **HRC** **GLV**



## SUN 02

SUN-002



**5a12**

1,3m

7u.

**DIM** 3,93 x 2,20m

**ZS** 6,32 x 5,20m

**MDR** **HRC** **GLV**



### SUN 03

SUN-003



**5a12**

**DIM** 3,93 x 3,95m

1,3m

**ZS** 7,72 x 5,17m

6u.

**MDR** **HRC** **GLV**



### SUN 04

SUN-004



**5a12**

**DIM** 5,35 x 3,93m

1,3m

**ZS** 7,72 x 6,51m

8u.

**MDR** **HRC** **GLV**



### SUN 05

SUN-005



**5a12**

**DIM** 3,93 x 3,60m

1,3m

**ZS** 6,60 x 6,32m

10u.

**MDR** **HRC** **GLV**



### SUN 051

SUN-051



**5a12**

**DIM** 5,00 x 3,93m

1,3m

**ZS** 8,00 x 6,32m

12u.

**MDR** **HRC** **GLV**





## SUN 052

SUN-052



**5a12**

**DIM** 6,81 x 3,39m

1,3m

**ZS** 8,56 x 7,72m

13u.

**MDR** **HRC** **GLV**



## SUN 06

SUN-006



**5a12**

**DIM** 6,23 x 3,93m

1,3m

**ZS** 8,66 x 6,54m

13u.

**MDR** **HRC** **GLV**



## SUN 07

SUN-007



**5a12**

**DIM** 8,85 x 3,59m

1,3m

**ZS** 10,72 x 6,08m

26u.

**MDR** **HRC** **GLV**



## SUN 08

SUN-008



**5a12**

**DIM** 7,79 x 6,08m

1,3m

**ZS** 10,74 x 8,50m

30u.

**MDR** **HRC** **GLV**



# TORNADUS



## TORNADUS 01

TOR-001



**5a12**

1,3m

5u.

**DIM** 3,55 x 1,54m

**ZS** 4,46 x 6,05m

**M** **H** **G** **AL**



## TORNADUS 02

TOR-002



**5a12**

1,3m

12u.

**DIM** 6,63 x 4,01m

**ZS** 9,66 x 7,02m

**M** **H** **G** **AL**



## TORNADUS 03

TOR-003



**5a12**

**DIM** 4,66 x 3,55m

1,3m

**ZS** 7,58 x 6,05m

10u.

**M H G AL**



## TORNADUS 04

TOR-004



**5a12**

**DIM** 4,01 x 3,51m

1,3m

**ZS** 6,53 x 7,02m

6u.

**M H G AL**





# JUEGA



## JUEGA 01

JUE-001

3a8

↓ 0,9m

⌚ 6u.

**DIM** 2,96 x 3,40m

**ZS** 5,89 x 5,79m

**M H G AL**



## JUEGA 02

JUE-002

3a8

↓ 1,30m

⌚ 10u.

**DIM** 4,20 x 4,13m

**ZS** 4,27 x 4,17m

**M H G AL**



### JUEGA 03

JUE-003



<b>3a8</b>	<b>DIM</b> 6,20 x 4,27m
1,30m	<b>ZS</b> 8,63 x 6,35m
16u.	<b>M H G AL</b>



### JUEGA 04

JUE-004



<b>3a8</b>	<b>DIM</b> 7,91 x 4,27m
1,30m	<b>ZS</b> 9,78 x 7,17m
20u.	<b>M H G AL</b>



### JUEGA 05

JUE-005



<b>3a8</b>	<b>DIM</b> 3,94 x 2,97m
0,90m	<b>ZS</b> 6,92 x 5,38m
10u.	<b>M H G AL</b>



### JUEGA 10

JUE-010



<b>3a12</b>	<b>DIM</b> 7,48 x 3,83m
1,30m	<b>ZS</b> 10,48 x 6,83m
19u.	<b>M H G AL</b>



# PANGEA



## PANGEA 01

PAN-001

**5a12**



1,30m



5u.

**DIM**

3,61 x 1,56m

**ZS**

6,17 x 4,54m

**INOX**



## PANGEA 02

PAN-002

**5a12**



1,30m



7u.

**DIM**

4,86 x 1,44m

**ZS**

7,27 x 4,43m

**INOX**

## PANGEA 03

PAN-003



5a12

**DIM** 6,32 x 3,45m

1,30m

**ZS** 9,11 x 6,42m

12u.

**INOX**

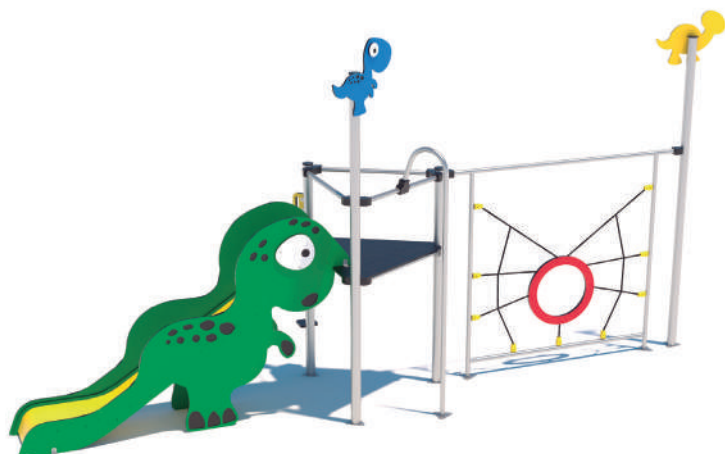

## PANGEA 04

PAN-004



5a12

**DIM** 6,12 x 1,44m

1,30m

**ZS** 8,53 x 4,42m

8u.

**INOX**

## PANGEA 05

PAN-005



5a12

**DIM** 6,41 x 3,02m

1,30m

**ZS** 9,11 x 5,69m

10u.

**INOX**

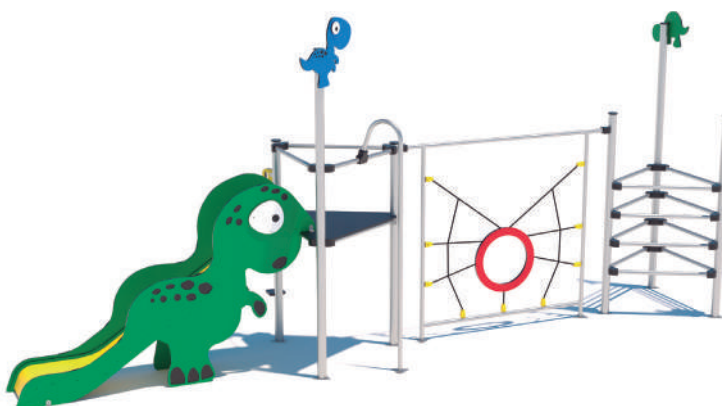

## PANGEA 06

PAN-006



5a12

**DIM** 6,07 x 5,69m

1,30m

**ZS** 8,71 x 8,59m

16u.

**INOX**



# ESPACIO



## COHETE 01

ESP-001

**1a5**

<0,6m

6u.

**DIM** 2,78 x 3,22m

**ZS** 5,15 x 5,75m

**INOX**



## COHETE 02

ESP-002

**1a8**

0,90m

8u.

**DIM** 5,05 x 2,59m

**ZS** 7,43 x 5,34m

**INOX**

## COHETE 03

ESP-003



1a8

**DIM** 3,96 x 6,59m

0,90m

**ZS** 9,42 x 6,80m

12u.

**INOX**



## COHETE 04

ESP-004

3a12

**DIM** 3,78 x 4,62m

1,30m

**ZS** 7,31 x 5,90m

16u.

**INOX**

## ESTACIÓN LUNAR

ESP-005



1a8

**DIM** 4,95 x 4,08m

0,60m

**ZS** 7,05 x 7,84m

17u.

**INOX**





# LUXURY



## LUXURY 01

LUX-001

**5a12**



1,30m



4u.

**DIM**

3,45 x 2,18m

**ZS**

5,93 x 5,16m

**INOX**



## LUXURY 02

LUX-002

**5a12**



1,30m



10u.

**DIM**

3,45 x 4,58m

**ZS**

5,93 x 7,57m

**INOX**

## LUXURY 03

LUX-003



**5a12**

**DIM** 3,45 x 1,10m

1,30m

**ZS** 5,94 x 3,96m

5u.

**INOX**



## LUXURY 04

LUX-004



**5a12**

**DIM** 5,90 x 4,63m

1,30m

**ZS** 8,34 x 7,56m

14u.

**INOX**

## LUXURY 05

LUX-005



**5a12**

**DIM** 6,90 x 2,23m

1,30m

**ZS** 9,40 x 5,16m

10u.

**INOX**



## LUXURY 06

LUX-006



**5a12**

**DIM** 4,54 x 3,91m

1,30m

**ZS** 6,92 x 5,55m

9u.

**INOX**



## LUXURY 07

LUX-007



**5a12**

**DIM** 10,48 x 5,07m

1,30m

**ZS** 13,21 x 7,57m

24u.

**INOX**





# MEC-AND



## MEC-AND 01

MEC-001



**5a12**

**DIM** 3,60 x 1,37m

 1,30m

**ZS** 6,10 x 4,35m

 4u.

**INOX**



## MEC-AND 02

MEC-002



**5a12**

**DIM** 3,60 x 3,11m

 1,30m

**ZS** 6,10 x 6,07m

 7u.

**INOX**



## MEC-AND 03

MEC-003



**5a12**

**DIM** 4,51 x 3,60m

1,30m

**ZS** 7,14 x 6,33m

5u.

**INOX**

## MEC-AND 04

MEC-004



**5a12**

**DIM** 5,79 x 3,60m

1,30m

**ZS** 7,61 x 7,16m

8u.

**INOX**



## MEC-AND 05

MEC-005



**5a12**

**DIM** 4,79 x 3,60m

1,30m

**ZS** 7,71 x 6,10m

10u.

**INOX**

## MEC-AND 6

MEC-006



**5a12**

**DIM** 6,08 x 3,60m

1,30m

**ZS** 9,03 x 6,10m

12u.

**INOX**



## MEC-AND 07

MEC-007



**5a12**

**DIM** 3,60 x 7,52m

1,30m

**ZS** 9,30 x 7,15m

11u.

**INOX**

## MEC-AND 08

MEC-008



**5a12**

**DIM** 3,60 x 8,81m

1,30m

**ZS** 10,61 x 7,15m

13u.

**INOX**





## MEC-AND 09

MEC-009



**1a12**

**DIM** 6,22 x 5,36m

**↓** <0,60m

**ZS** 9,43 x 8,36m

**☉** 11u.

**INOX**

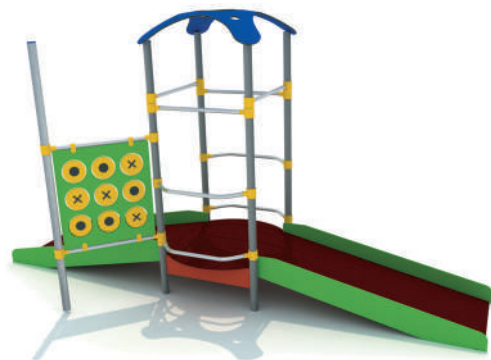

## MEC-AND 10

MEC-010



**1a12**

**DIM** 5,37 x 22,21m

**↓** <0,60m

**ZS** 8,36 x 5,20m

**☉** 7u.

**INOX**





# TLN TODOS LOS NIÑOS

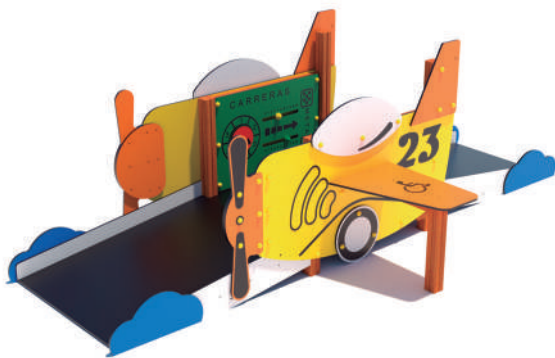

## AVIÓN TLN

TLN-009C



**1a12**

**DIM** 4,30 x 2,82m

**↓** <0,6m

**ZS** 7,30 x 5,82m

**⌚** 5u.

**MDR** **HRC** **GLV**



## AVIÓN CARGA TLN

TLN-009



**1a12**

**DIM** 6,00 x 2,82m

**↓** <0,6m

**ZS** 8,90 x 5,82m

**⌚** 10u.

**MDR** **HRC** **GLV**



## CIRC. INTERACTIVO

TLN-012



1a12

**DIM** 5,80 x 5,36m

↓ <0,6m

**ZS** 8,30 x 8,23m

☺ 16u.

**MDR** **GLV**



## TREN MINERO

TLN-016C



1a12

**DIM** 8,02 x 3,36m

↓ <0,6m

**ZS** 11,02 x 5,80m

☺ 18u.

**MDR** **GLV**

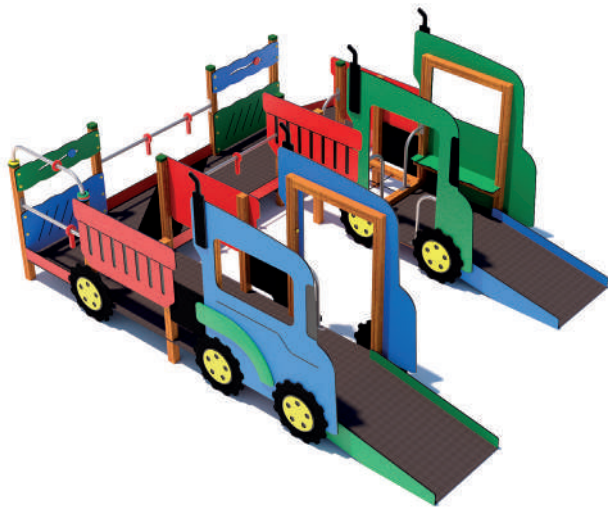

## CAMIÓN DUMPER

TLN-015



1a12

**DIM** 5,79 x 5,82m

↓ <0,6m

**ZS** 8,77 x 8,79m

☺ 18 u.

**MDR** **GLV**

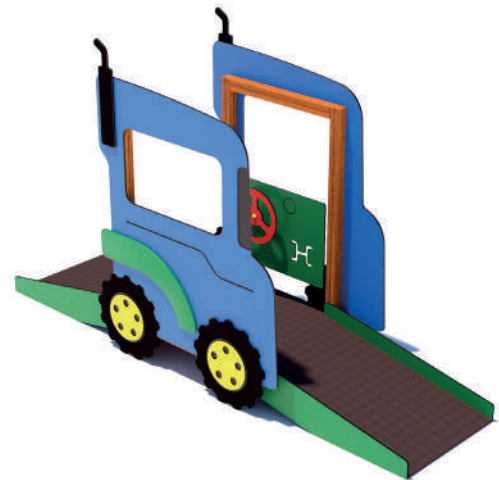

## CABINA CAMIÓN

TLN-015B



1a12

**DIM** 4,21 x 1,30m

↓ <0,6m

**ZS** 7,21 x 4,30m

☺ 5u.

**MDR** **HRC** **GLV**



## CAMIÓN RECICLAJE

TLN-016



1a12

**DIM** 6,03 x 5,42m

<0,6m

**ZS** 8,53 x 8,28m

18u.

**MDR** **GLV**



## CAMIÓN BOMB. TLN

TLN-010



1a12

**DIM** 3,73 x 2,08m

<0,6m

**ZS** 6,73 x 5,08m

16 u.

**MDR** **HRC** **GLV**



## CAMIÓN BASE BOMBEROS

TLN-019



1a12

**DIM** 9,27 x 5,26m

1,30m

**ZS** 12,22 x 6,53m

30u.

**MDR** **GLV**

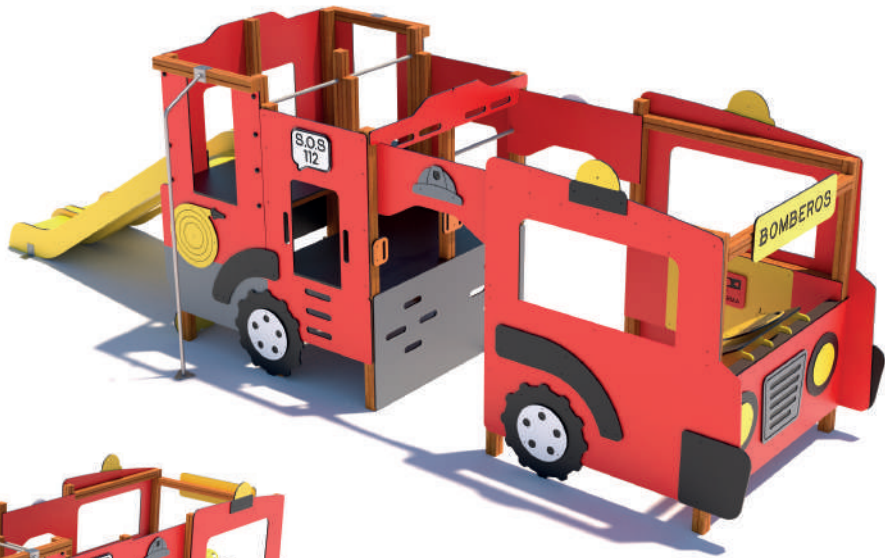

## TREN BOMBEROS XL

TLN-020



1a12

**DIM** 7,45 x 2,71m

↓ 1,30m

**ZS** 9,81 x 5,68m

⊙ 26u.

**MDR HRC GLV**



## COLUMPIO NIDO

TLN-002



3a12

**DIM** 3,46 x 1,35m

↓ 1,30m

**ZS** 3,41 x 7,00m

⊙ 4u.

**MDR HRC GLV**



## COLUMPIO TLN

TLN-014



3a12

↓ 1,30m

⊙ 2u.

**M H G**



TLN-014C

TLN-014D

TLN-014E



## BARCO PEQUE TLN

PIR-007-TLN



**1a5**

**DIM** 3,45 x 4,66m

**↓** 0,9m

**ZS** 6,08 x 7,16m

**☉** 5u.

**MDR** **GLV**



## CONCORDIA TLN

PIR-008-TLN



**1a12**

**DIM** 6,21 x 7,06m

**↓** 0,9m

**ZS** 9,22 x 9,06m

**☉** 18 u.

**MDR** **GLV**



## RANGER TLN

PIR-011-TLN



**1a12**

**DIM** 13,47 x 7,67m

**↓** 1,3m

**ZS** 15,26 x 10,15m

**☉** 24 u.

**MDR** **GLV**

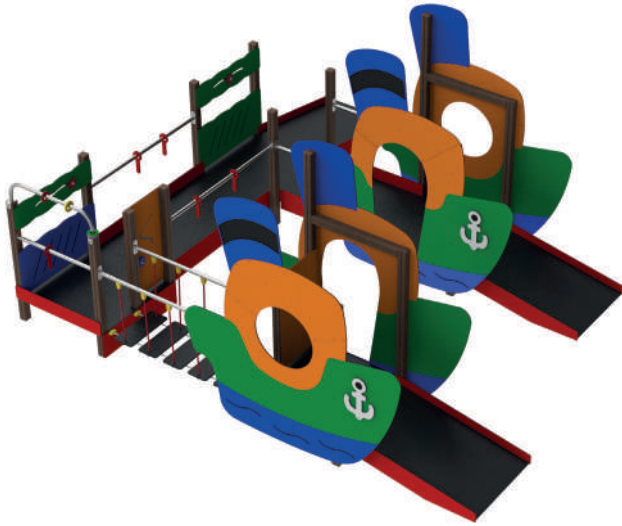

## PESQUERO TLN

TLN-013



**1a12**

 0,6m

 18u.

**DIM** 5,79 x 5,79m

**ZS** 8,77 x 8,79m

**MDR** **GLV**





# BOSQUE ÁRBOL



## CASITA BOSQUE

BOS-001

1a12



0,6m



4u.

**DIM**

1,88 x 1,00m

**ZS**

3,87 x 3,09m

**MDR**

**GLV**

**AL**



## 1 TORRE

BOS-002

5a12



1,30m



5u.

**DIM**

2,69 x 4,24m

**ZS**

6,74 x 5,71m

**MDR**

**GLV**

**AL**

## TORRE + RED

BOS-003

5a12

**DIM** 2,71 x 4,71m

↓ 1,30m

**ZS** 7,19 x 5,71m

☺ 9u.

**MDR** **GLV** **AL**



## 2 TORRES

BOS-004

5a12

**DIM** 5,72 x 4,24m

↓ 1,30m

**ZS** 8,13 x 6,66m

☺ 14u.

**MDR** **GLV** **AL**

## 3 TORRES

BOS-005

5a12

**DIM** 6,58 x 7,77m

↓ 1,30m

**ZS** 9,13 x 9,28m

☺ 18u.

**MDR** **GLV** **AL**

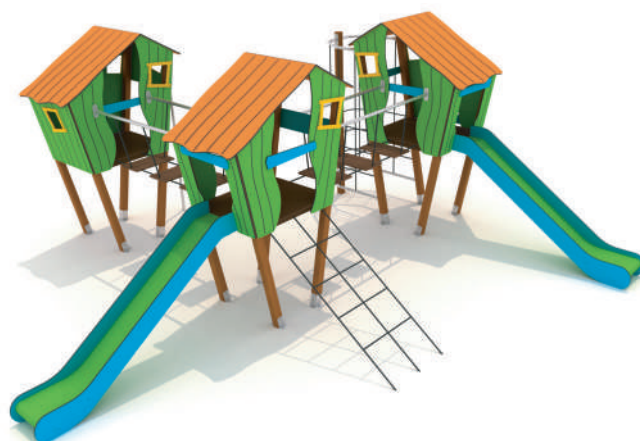



## GRAN BOSQUE

BOS-009

5a12

**DIM** 7,30 x 3,57m

 1,90m

**ZS** 10,72 x 6,86m

 10u.

**MDR** **GLV** **AL**

## GRAN BOSQUE 2

BOS-010

5a12

**DIM** 10,71 x 5,79m

 1,90m

**ZS** 14,17 x 8,73m

 10u.

**MDR** **GLV** **AL**

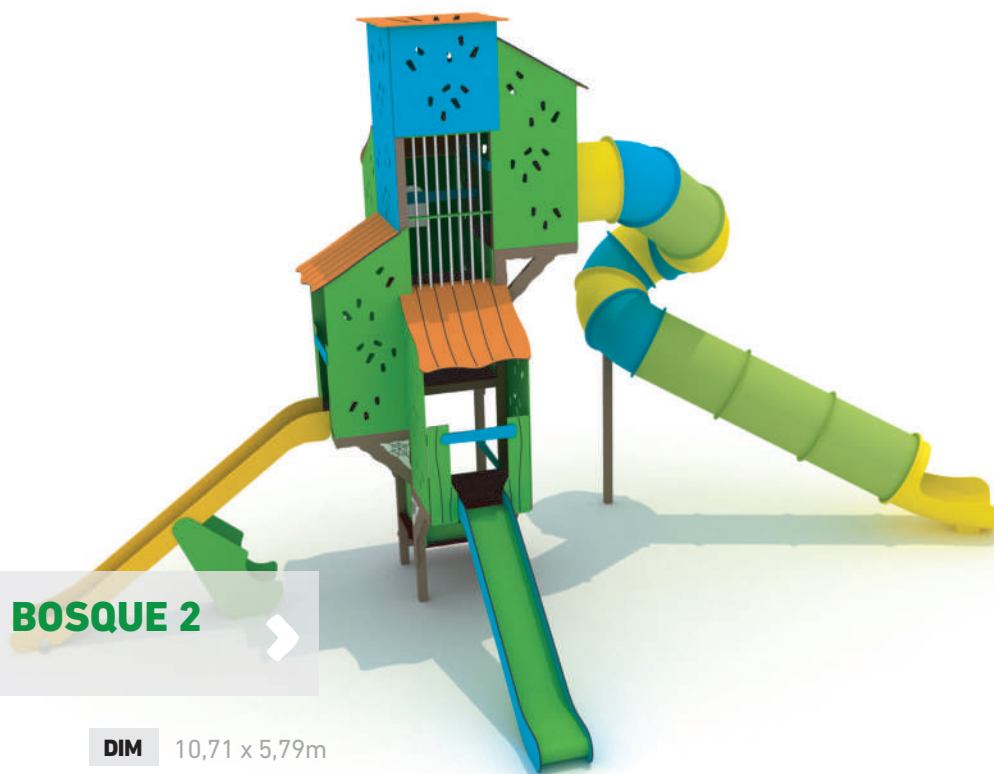



## CASA ÁRBOL

ARB-001

5a12

**DIM** 4,07 x 3,24m

↓ 1,30m

**ZS** 6,32 x 5,92m

⌚ 9u.

**MDR**



## CASA ÁRBOL 2T

ARB-002

5a12

**DIM** 4,07 x 11,29m

↓ 1,90m

**ZS** 14,75 x 6,32m

⌚ 16u.

**MDR**



## CASA ÁRBOL 3T

ARB-003

5a12

**DIM** 8,47 x 11,29m

↓ 1,90m

**ZS** 14,75 x 10,38m

⌚ 24u.

**MDR**

### MADERA + HDPE

Los paneles de esta serie están fabricados en HDPE de 15mm bicolor.



## ÁRBOL

ARB-004

5a12

**DIM** 3,64 x 7,86m

↓ 2,00m

**ZS** 11,35 x 6,56m

⊙ 10u.

**MDR** **HRC** **GLV**





# CASTILLOS



## CASTILLO 2T

CAS-014

3a12

**DIM** 2,80 x 6,31m

↓ 0,90m

**ZS** 5,69 x 8,81m

⌚ 12u.

**MDR** **GLV** **AL**



## CASTILLO 3T

CAS-015

3a12

**DIM** 5,97 x 8,54m

↓ 1,30m

**ZS** 10,88 x 8,82m

⌚ 20u.

**MDR** **GLV** **AL**



## FUERTE PEQUEÑO

CAS-004

1a12

**DIM** 7,49 x 8,77m

↓ 1,30m

**ZS** 10,42 x 10,88m

⌚ 20u.

**MDR** **GLV** **AL**



## CASTILLO 4T

CAS-016

3a12

**DIM** 5,97 x 8,54m

↓ 1,30m

**ZS** 10,88 x 8,82m

⌚ 20u.

**MDR** **GLV** **AL**



## CASTLE

CAS-008

1a12



1,30



30u.

**DIM** 8,54 x 8,56m

**ZS** 10,88 x 10,90m

**MDR** **GLV** **AL**

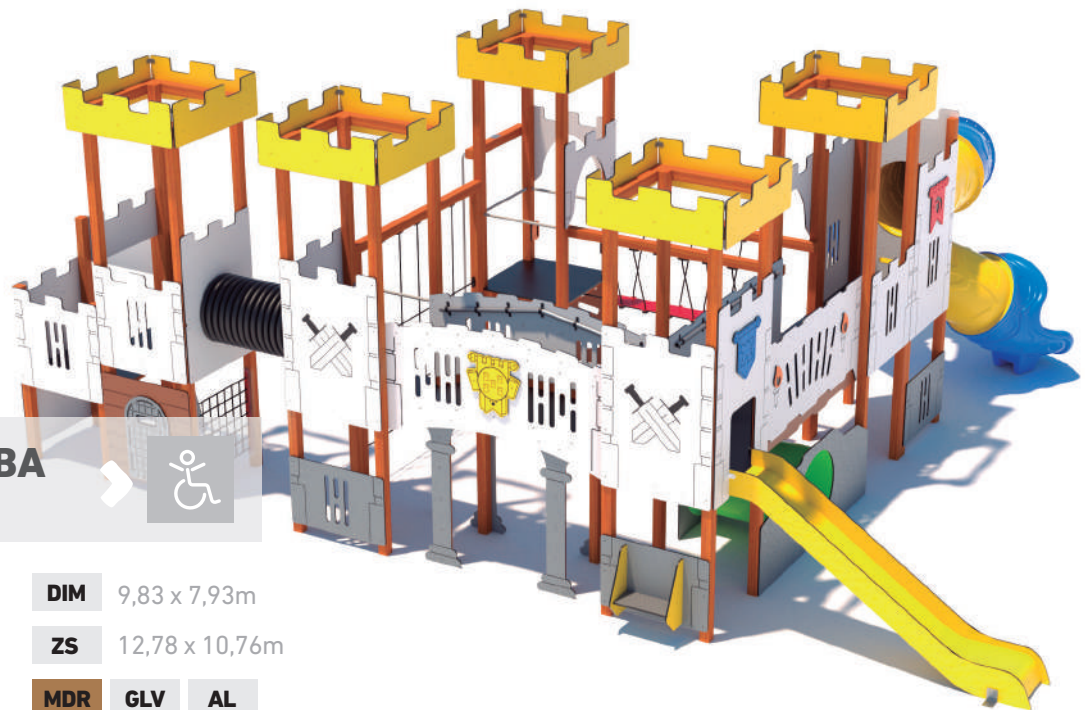

## ALCAZABA

CAS-013

1a12



1,30m



48u.

**DIM** 9,83 x 7,93m

**ZS** 12,78 x 10,76m

**MDR** **GLV** **AL**

# ¿CON CUAL TE QUEDAS?



## ESTRUCTURA Y COLOR

Elige entre madera laminada, aluminio o acero galvanizado y polietileno variedad BLANCO o en variedad COLOR.



OPCIÓN COLOR

OPCIÓN BLANCO



**FUERTE**  
CAS-001

3a12

<2m

60u.

**DIM** 7,84 x 12,91m

**ZS** 15,20 x 10,36m

**MDR** **GLV** **AL**



## CABALLO GUERRERO

MED-M01

**3a12**

**DIM** 0,91 x 0,31m

**↓** <0,60m

**ZS** 2,47 x 2,34m

**☉** 12u.



## BALANCIN TORRES

MED-B01

**3a12**

**DIM** 3,01 x 0,31m

**↓** <0,60m

**ZS** 5,09 x 2,34m

**☉** 4u.

**MDR** **GLV**





# VINÍCOLA



## MESITA CON BANCO

VIN-001



**1a12**

**DIM** 0,95 x 0,77m

**↓** <0,60m

**ZS** 2,75 x 3,95m

**☺** 2u.

**MDR**



## BARRICALL

VIN-002



**1a12**

**DIM** 0,71 x 0,15m

**↓** <0,60m

**ZS** 3,71 x 3m

**☺** 1u.

**MDR**

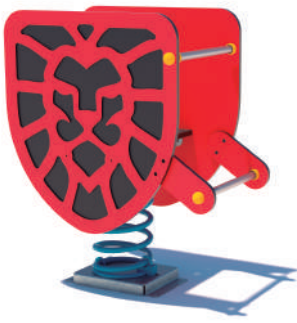

## GEOLEÓN

VIN-006

1a12 <0,6m 1u.

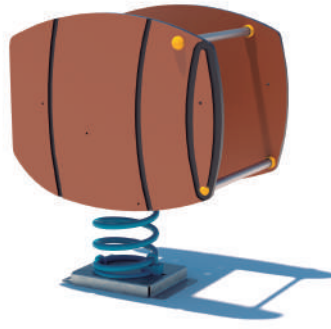

## BARRIL

VIN-005

1a12 <0,6m 1u.

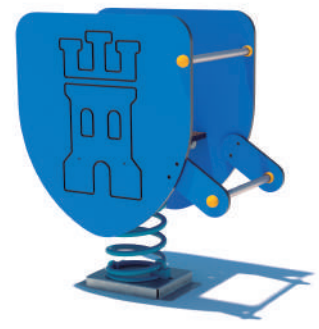

## CASTILLO

VIN-004

1a12 <0,6m 1u.



## RACIMO

VIN-003

3a12 <0,6m 1u.



## DOBLE RACIMO

VIN-007

3a12 <0,6m 2u.



## VINICOLUMPIO

VIN-008

3a12 1,30m 2u.

**DIM** 3,49 x 1,54m

**ZS** 4,00 x 7,00m



## GRAN CASTILLO

VIN-009



**1a12**



1,30m

**DIM**

13,81 x 15,13m

**ZS**

16 x 17m



179u.

**MDR**





# MEDIEVO



## MEDIEVO 01

MED-001

**5a12**



1,30m



12u.

**DIM**

5,09 x 5,33m

**ZS**

8,09 x 7,89m

**MDR**

**GLV**



## MEDIEVO 02

MED-002

**1a5**



0,90m



12u.

**DIM**

5,97 x 4,11m

**ZS**

8,96 x 6,61m

**MDR**

**GLV**



### MEDIEVO 03

MED-003

5a12

**DIM** 5,24 x 2,75m

↓ 1,30m

**ZS** 7,72 x 5,75m

☉ 12u.

**MDR** **GLV**

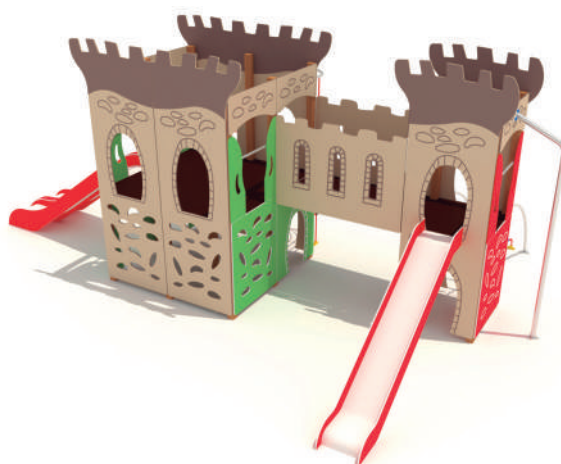

### MEDIEVO 04

MED-004

5a12

**DIM** 7,94 x 5,40m

↓ 1,30m

**ZS** 10,42 x 7,89m

☉ 16u.

**MDR** **GLV**

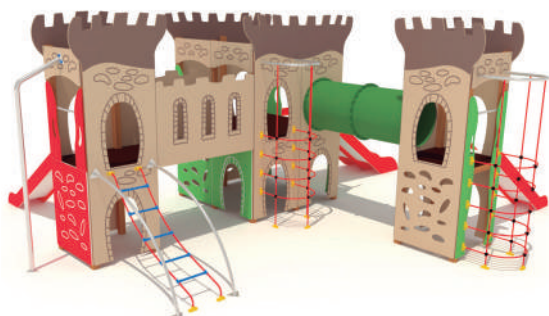

### MEDIEVO 05

MED-005

5a12

**DIM** 7,94 x 7,29m

↓ 1,30m

**ZS** 10,44 x 9,78m

☉ 22u.

**MDR** **GLV**



### MEDIEVO 05A

MED-005A

5a12

**DIM** 8,99 x 7,22m

↓ 1,30m

**ZS** 12,45 x 9,74m

☉ 22u.

**MDR** **GLV**

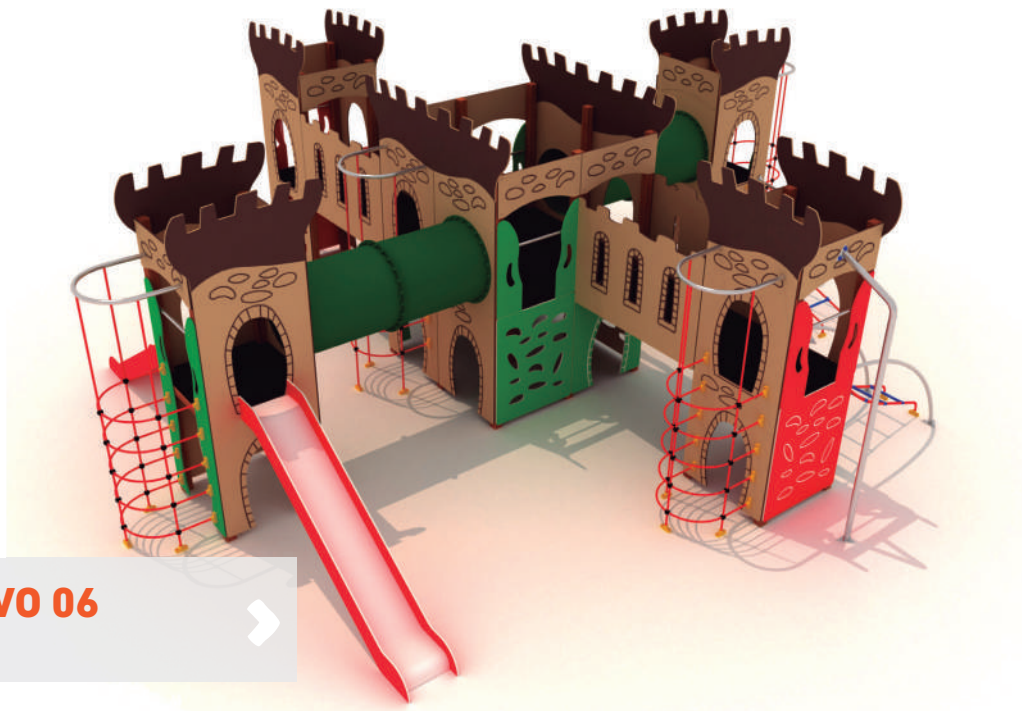

## MEDIEVO 06

MED-006

5a12

**DIM** 8,71 x 9,40m

↓ 1,30m

**ZS** 11,72 x 12,41m

☉ 34u.

**MDR** **GLV**



## MEDIEVO 07

MED-007

5a12

**DIM** 9,12 x 4,76m

↓ 1,30m

**ZS** 11,60 x 7,26m

☉ 16u.

**MDR** **GLV**



# PIRATAS





## BANDERA

PIR-025

1a12 <0,6m 1u.



## PIRATA

PIR-026

1a12 <0,6m 1u.

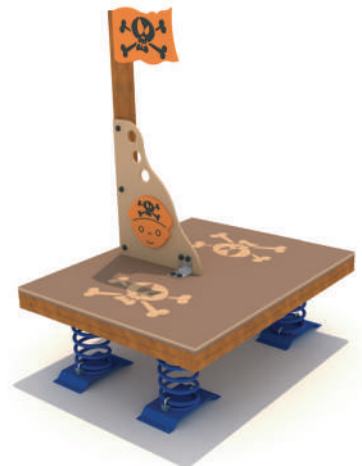

## BALSA PIRATA

PIR-003

1a5 <0,6m 2u.

**DIM** 1,50 x 1,20m

**ZS** 4,50 x 420m

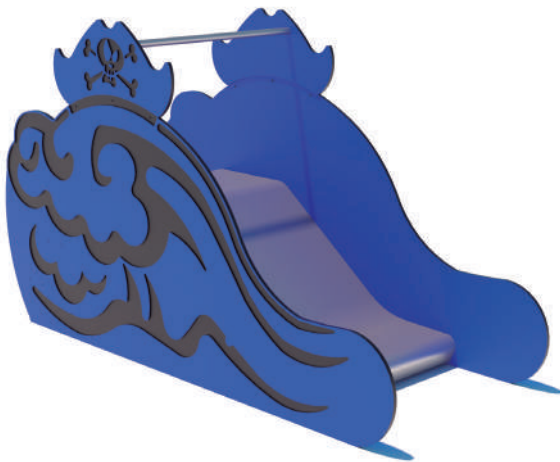

## TOBOGÁN OLA

PIR-004

1a5 **DIM** 2,75 x 0,83m

<0,6m **ZS** 5,75 x 3,83m

2u.



## CASITA MAPA

PIR-005

1a5 **DIM** 1,27 x 1,12m

<0,6m **ZS** 4,27 x 4,03m

4u.

**INOX**



## BARCO PEQUE

PIR-007

1a5

**DIM** 3,45 x 4,66m

↓ 0,90m

**ZS** 6,08 x 7,16m

☺ 8u.

**MDR**



## CONCORDIA

PIR-008

1a12

**DIM** 6,21 x 7,06m

↓ 0,9m

**ZS** 9,21 x 9,06m

☺ 9u.

**MDR**



## REVENGE

PIR-009

1a12

**DIM** 8,28 x 7,50m

↓ 1,30m

**ZS** 10,51 x 10,16m

☺ 15u.

**MDR**

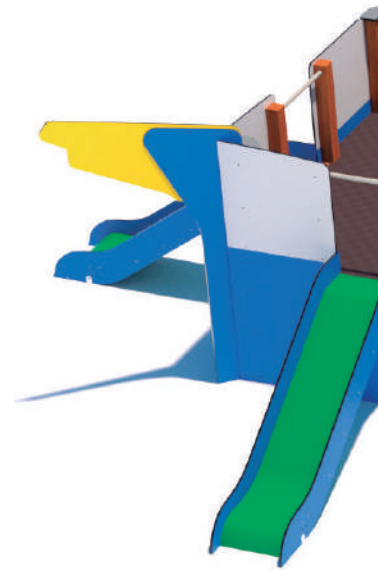

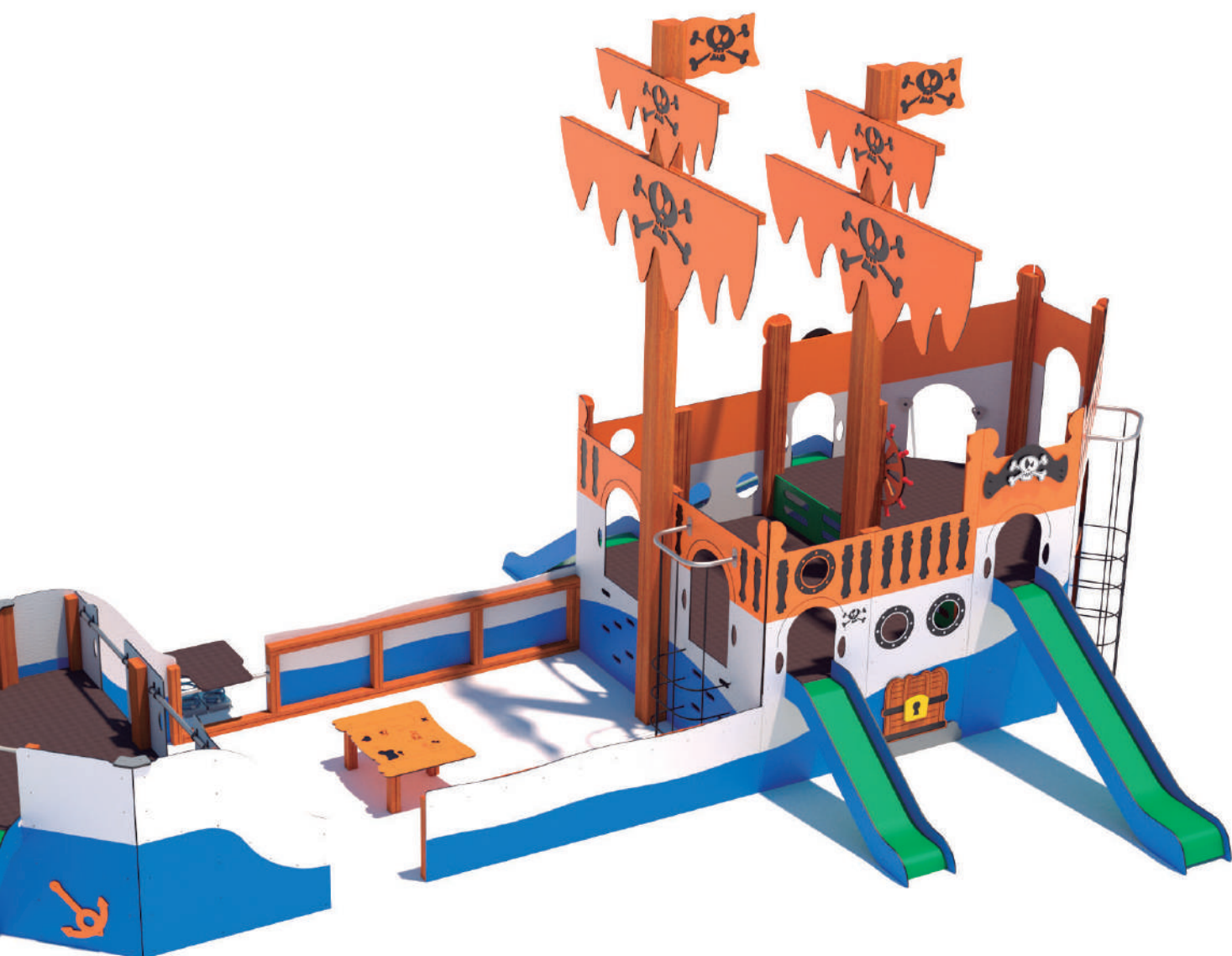

## RANGER

PIR-010



**1a12**



1,30m



24u.

**DIM**

13,07 x 8,28m

**ZS**

15,42 x 10,28m

**MDR**

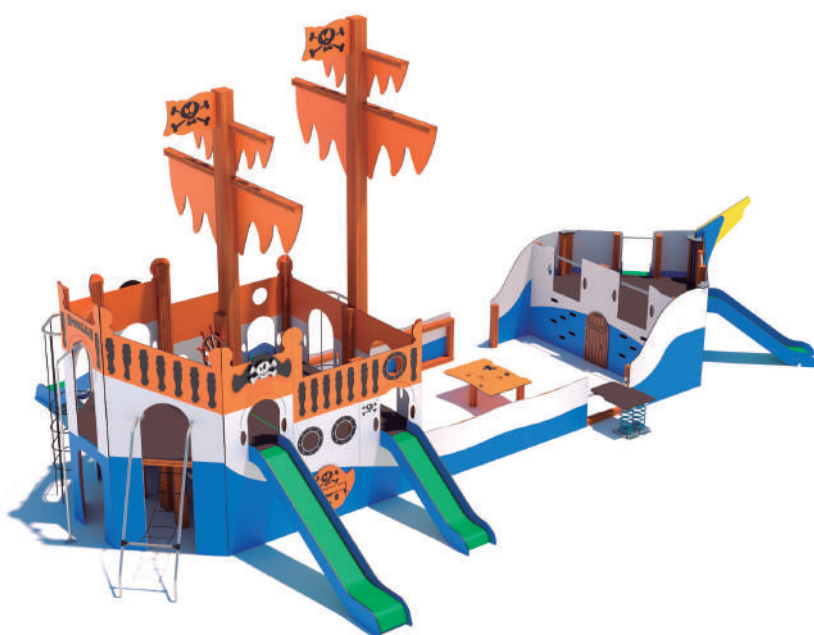



# DiNOS

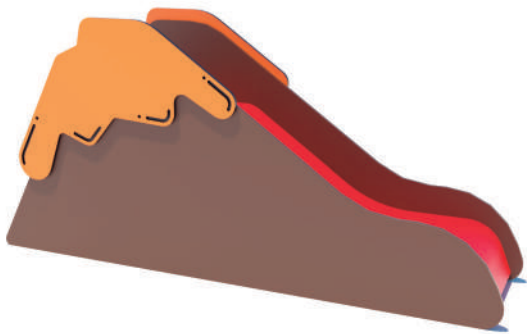

## VOLCÁN

DIN-005

**1a5**

<0,60m

2u.

**DIM** 2,07 x 0,49m

**ZS** 4,19 x 3,49m



## DINOCALL

DIN-006

**1a12**

--m

2u.

**DIM** 1,58 x 0,15m

**ZS** --m

**MDR** **HRC** **GLV**

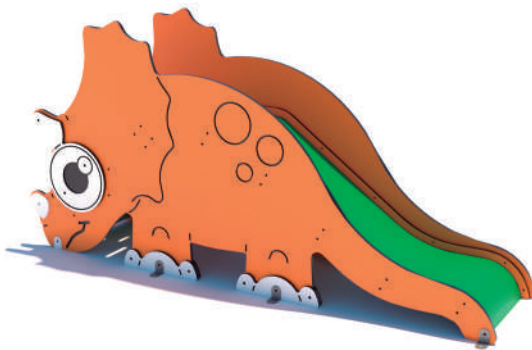

## TRICERATOPS

DIN-003

1a5

**DIM** 2,10 x 0,51m

↓ <0,60m

**ZS** 4,56 x 3,49m

☺ 2u.

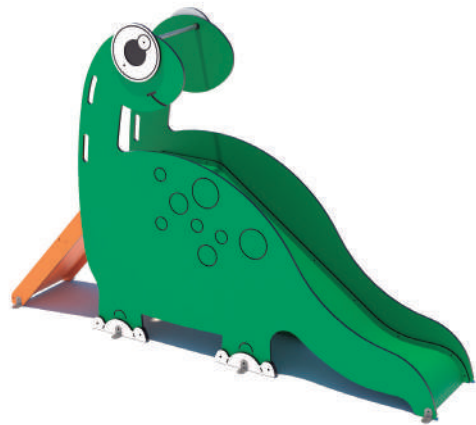

## DIPLO

DIN-004

3a12

**DIM** 2,66 x 0,52m

↓ 0,90m

**ZS** 5,58 x 3,49m

☺ 2u.

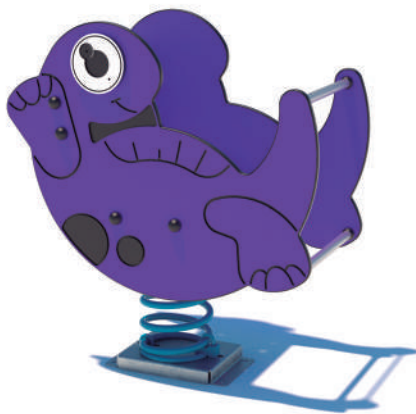

## MUELLE DINO

DIN-M01

1a5

**DIM** 0,91 x 0,31m

↓ <0,60m

**ZS** 2,47 x 2,34m

☺ 1u.



## PARASAURO

DIN-009

3a12

**DIM** 4,73 x 0,86m

↓ 0,90m

**ZS** 7,58 x 3,80m

☺ 5u.

**MDR** **HRC** **GLV**



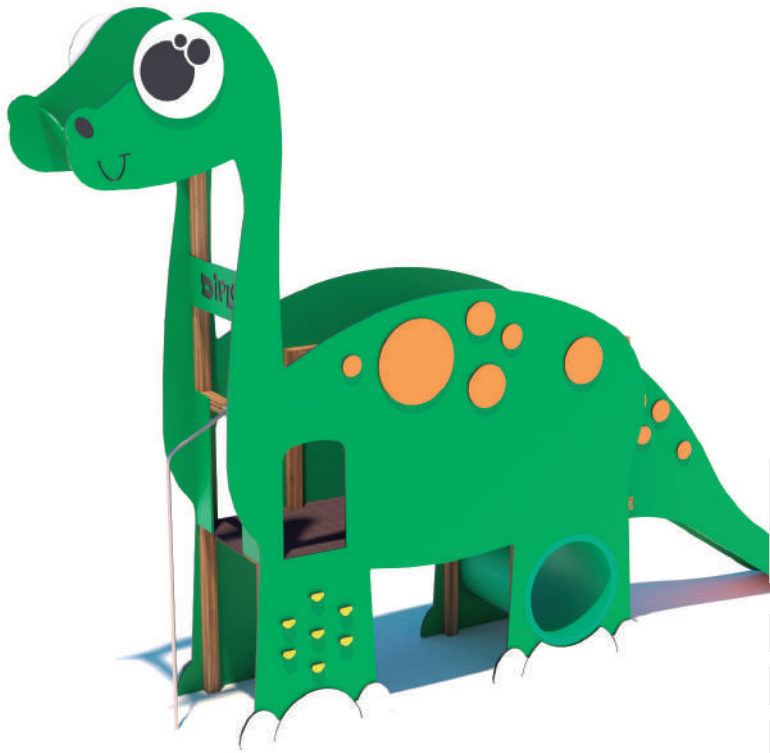

## DIPLODOCUS

DIN-002



3a12

↓ 1,30m

☺ 14u.

**DIM** 6,98 x 1,06m

**ZS** 8,60 x 4,00m

**MDR** **HRC** **GLV**

4,90m



## T-REX

DIN-001



3a12

↓ 1,30m

☺ 20u.

**DIM** 8,18 x 2,26m

**ZS** 10,37 x 5,26m

**MDR** **HRC** **GLV**



# ANIMALES



## CASITA LEÓN

ANI-001

1a5

↓ <0,6m

⌚ 5u.

**DIM** 1,85 x 1,18m

**ZS** 4,85 x 4,18m

**INOX**

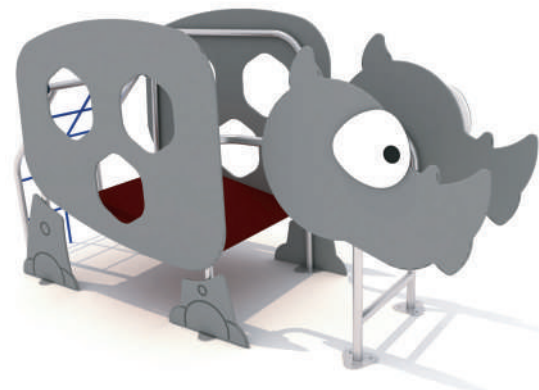

## RHINO

ANI-004

3a12

↓ 1,20m

⌚ 4u.

**DIM** 2,87 x 0,95m

**ZS** 5,87 x 3,95m

**INOX**



## PANDA

ANI-002

**5a12**

**DIM** 3,44 x 2,49m

**↓** 1,30m

**ZS** 5,91 x 5,49m

**☉** 4u.

**INOX**



## JIRAFÁ

ANI-003

**3a12**

**DIM** 3,37 x 1,50m

**↓** 1,30m

**ZS** 5,87 x 4,40m

**☉** 4u.

**INOX**

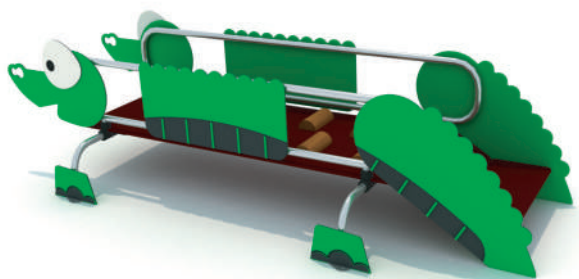

## COCODRILO

ANI-005

**1a5**

**DIM** 3,51 x 1,56m

**↓** <0,6m

**ZS** 6,51 x 4,47m

**☉** 6u.

**INOX**



## TORTUGA

ANI-007

**1a5**

**DIM** 2,59 x 1,03m

**↓** <0,6m

**ZS** 5,12 x 3,94m

**☉** 4u.

**INOX**



## AVESTRUZ PEQUE

ANI-009

<b>1a5</b>	<b>DIM</b> 2,63 x 0,55m
<b>↓</b> 0,90m	<b>ZS</b> 5,17 x 3,52m
<b>☉</b> 2u.	<b>INOX</b>



## AVESTRUZ

ANI-010

<b>3a12</b>	<b>DIM</b> 3,24 x 0,55m
<b>↓</b> 1,30m	<b>ZS</b> 5,64 x 3,52m
<b>☉</b> 2u.	<b>INOX</b>

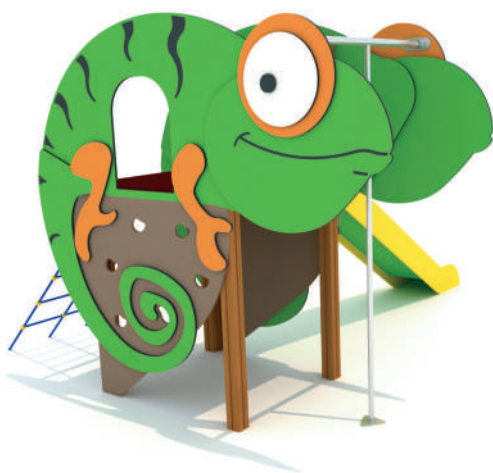

## CAMALEÓN

ANI-012

<b>3a12</b>	<b>DIM</b> 3,31 x 3,59m
<b>↓</b> 1,30m	<b>ZS</b> 6,04 x 6,31m
<b>☉</b> 10u.	<b>M H G AL</b>



## COL. ARDILLA

ANI-011

<b>3a12</b>	<b>DIM</b> 3,46 x 1,39m
<b>↓</b> 1,30m	<b>ZS</b> 7,00 x 3,46m
<b>☉</b> 2u.	<b>MDR HRC GLV</b>

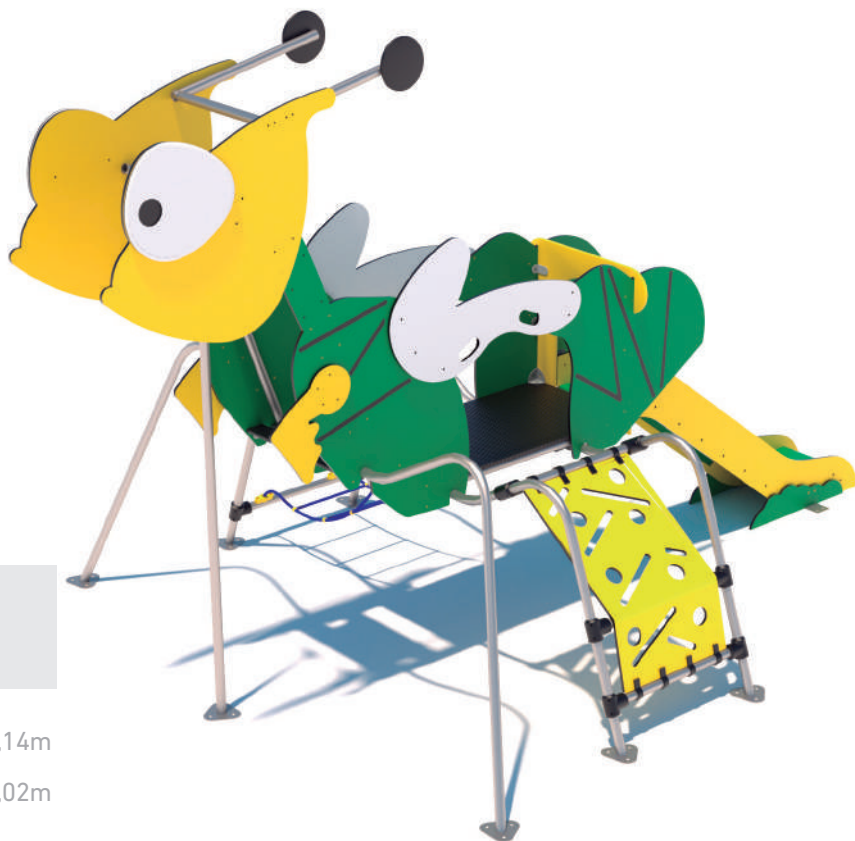

## SALTAMONTES

ANI-006

**3a12**

**DIM** 4,59 x 3,14m

**↓** 1,30m

**ZS** 7,07 x 6,02m

**☉** 5u.

**INOX**

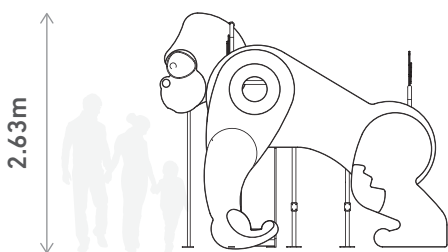

## GORILA

ANI-008

**3a12**

**DIM** 3,22 x 4,22m

**↓** 1,30m

**ZS** 6,22 x 6,69m

**☉** 8u.

**INOX**





## VACA

ANI-014

1a12

↓ 1,30m

⊙ 8u.

**DIM** 4,72 x 3,15m

**ZS** 6,11 x 7,20m

**INOX**

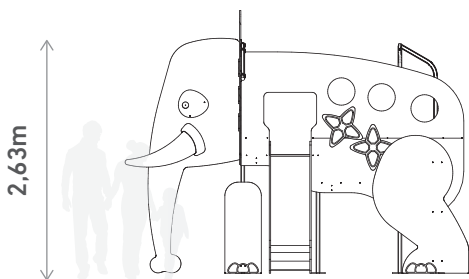

2,63m

## ELEFANTE

ANI-015

3a12

↓ 1,30m

⊙ 8u.

**DIM** 3,77 x 6,19m

**ZS** 8,19 x 6,77m

**INOX**

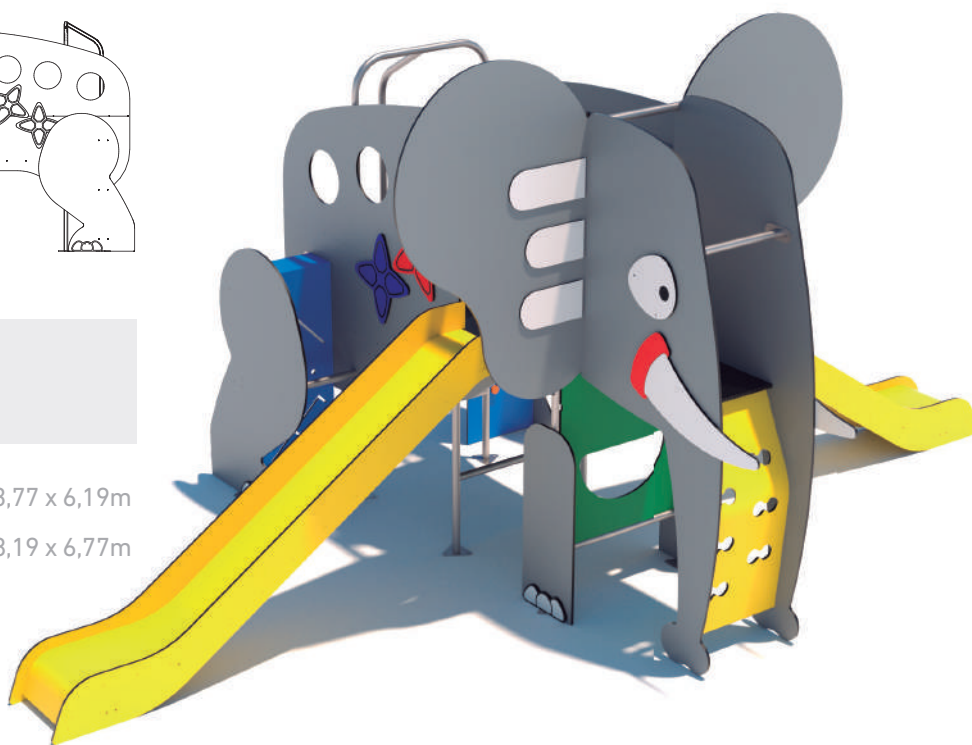

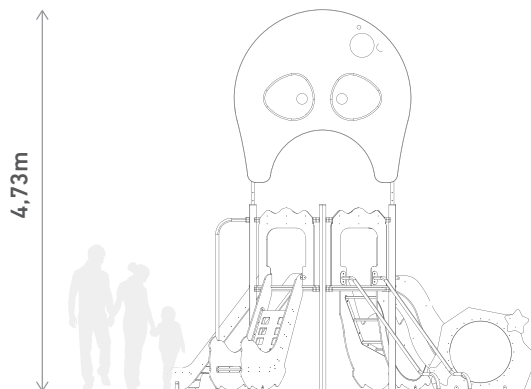

## PULPO

ANI-013

**3a12**

**DIM** 5,78 x 4,44m

**↓** 1,30m

**ZS** 6,97 x 8,90m

**☉** 20u.

**INOX**

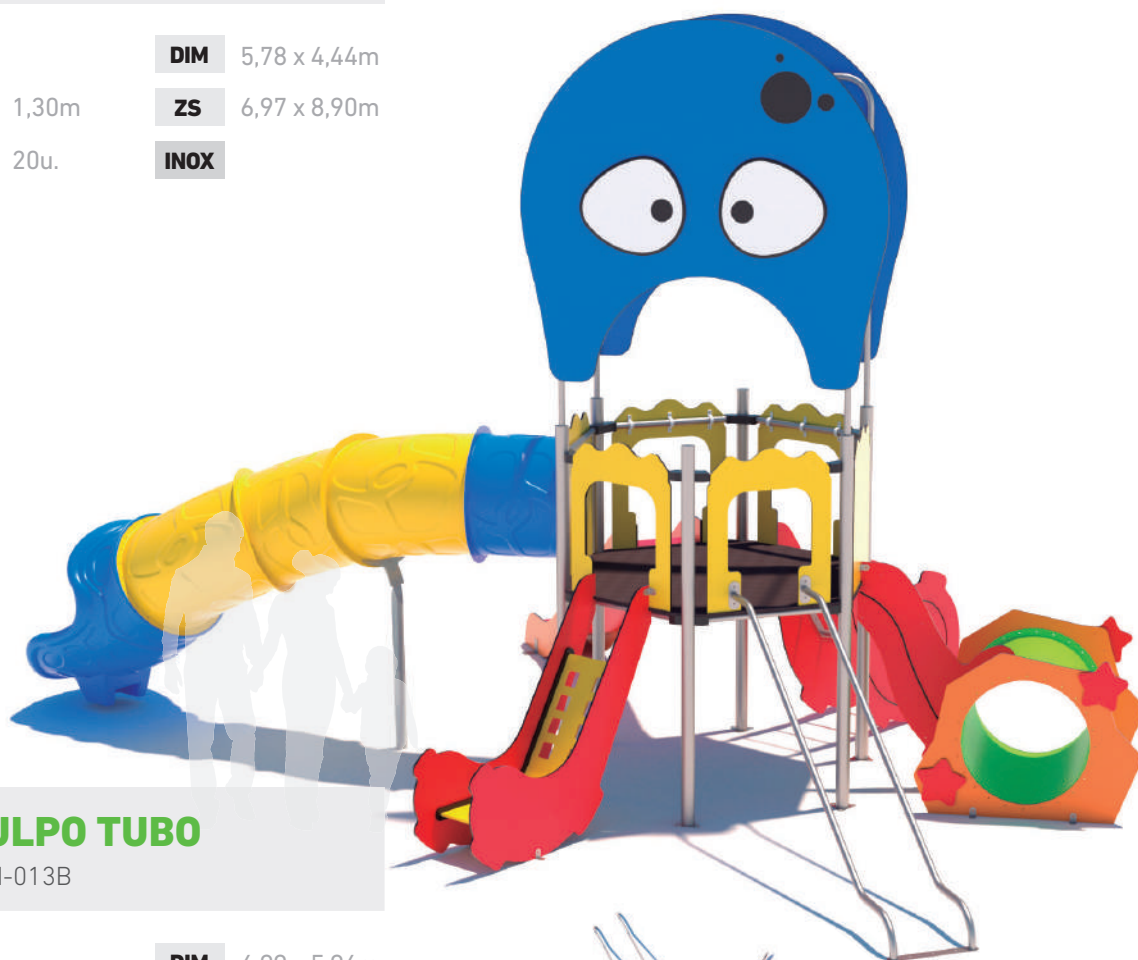

## PULPO TUBO

ANI-013B

**3a12**

**DIM** 6,99 x 5,96m

**↓** 1,30m

**ZS** 10,48 x 6,90m

**☉** 20u.

**MDR** **HRC** **GLV**

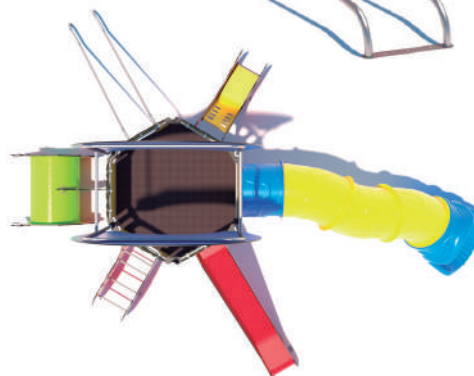



## POLLITO

ANI-016

<b>1a5</b>	<b>DIM</b> 0,80 x 2,79m
0,60m	<b>ZS</b> 5,29 x 3,85m
4u.	<b>MDR</b> <b>HRC</b> <b>GLV</b>



## HIPOPÓTAMO

ANI-017

<b>1a5</b>	<b>DIM</b> 0,80 x 3,29m
0,90m	<b>ZS</b> 5,79 x 3,85m
4u.	<b>MDR</b> <b>HRC</b> <b>GLV</b>



## BÚHO

ANI-018

<b>1a5</b>	<b>DIM</b> 0,80 x 3,29m
0,90m	<b>ZS</b> 5,79 x 3,85m
4u.	<b>MDR</b> <b>HRC</b> <b>GLV</b>



## RANA

ANI-019

<b>1a5</b>	<b>DIM</b> 0,80 x 3,29m
0,90m	<b>ZS</b> 5,79 x 3,85m
4u.	<b>MDR</b> <b>HRC</b> <b>GLV</b>



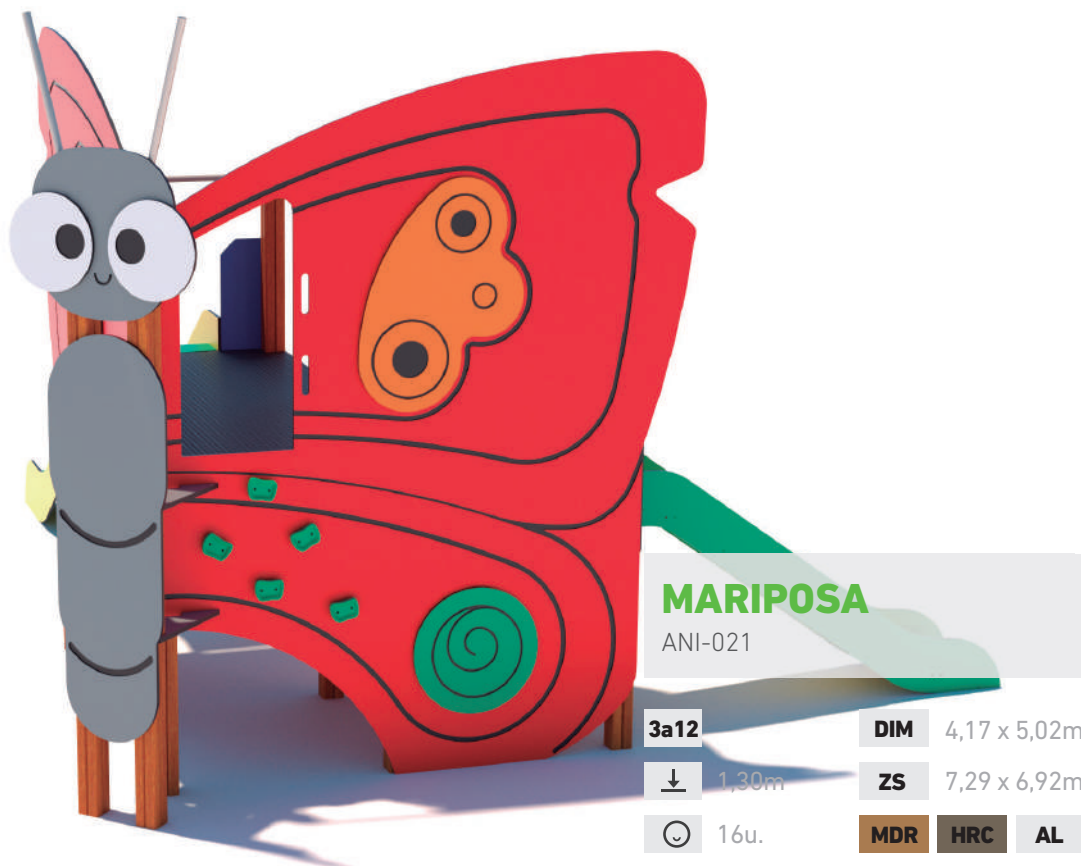

## MARIPOSA

ANI-021

<b>3a12</b>	<b>DIM</b>	4,17 x 5,02m
1,30m	<b>ZS</b>	7,29 x 6,92m
16u.	<b>MDR</b>	<b>HRC</b> <b>AL</b>

## MARIQUITA

ANI-022

<b>3a12</b>	<b>DIM</b>	2,88 x 5,21m
1,30m	<b>ZS</b>	5,77 x 7,55m
9u.	<b>MDR</b>	<b>HRC</b> <b>AL</b>





## PROYECTO PARQUE ANIMAL PLAY

—  
ANI-021 MARIPOSA  
ANI-022 MARIQUITA  
BAL-044 MUELLE LEON INCLUSIVO  
VELA TENSADA



# AVIONES

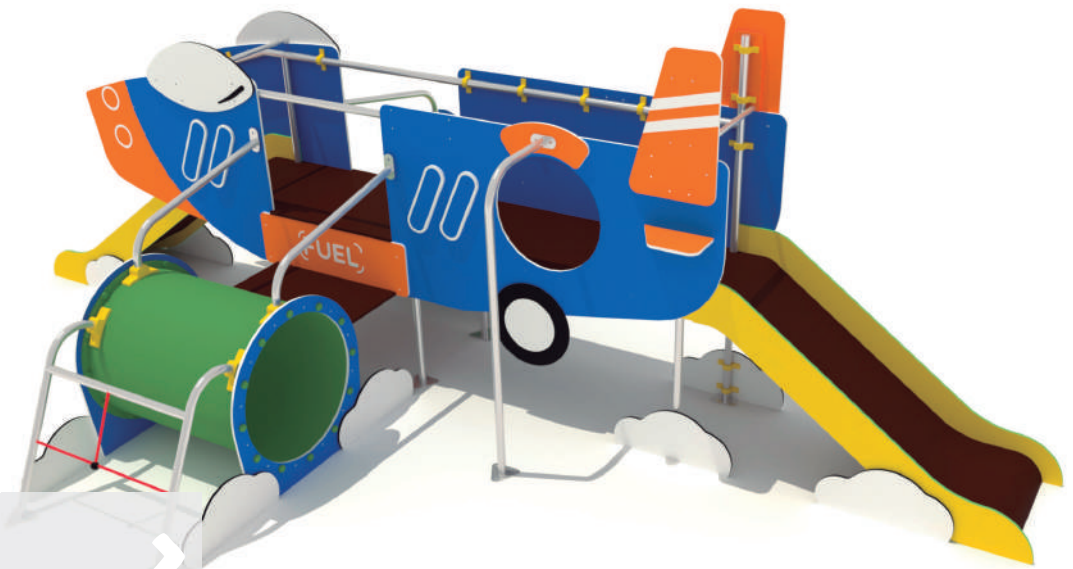

## REACTOR

AVI-001

**1a12**

↓ 0,90m

⊙ 8u.

**DIM** 6,51 x 4,87m

**ZS** 8,51 x 7,76m

**INOX**



## AVIONETA

AVI-002

<b>1a12</b>	<b>DIM</b> 4,58 x 4,30m
0,90m	<b>ZS</b> 7,45 x 6,30m
8u.	<b>INOX</b>



## PARQUE BOMBEROS

PAR-001

<b>1a12</b>	<b>DIM</b> 3,95 x 4,05m
1,30 / 2,1m	<b>ZS</b> 6,99 x 6,00m
13u.	<b>MDR</b>



## MUELLE AVIÓN

MUE-011

<b>3a12</b>	<b>DIM</b> 0,92 x 0,46m
<0,6m	<b>ZS</b> 2,92 x 2,46m
1u.	



## TOBOGÁN AVIÓN

AVI-003

<b>3a12</b>	<b>DIM</b> 3,50 x 0,49m
1,30m	<b>ZS</b> 6,00 x 3,49m
2u.	



## AVIOCAR

AVI-005



**1a12**

 2,00m

40u.

**DIM** 16,32 x 16,04m

**ZS** 19,04 x 19,33m

**INOX GLV**





# BARCOS



## BARCO 01

BAR-001



**1a5**

**DIM** 5,95 x 3,14m

 0,90m

**ZS** 8,95 x 5,64m

 10u.

**MDR**

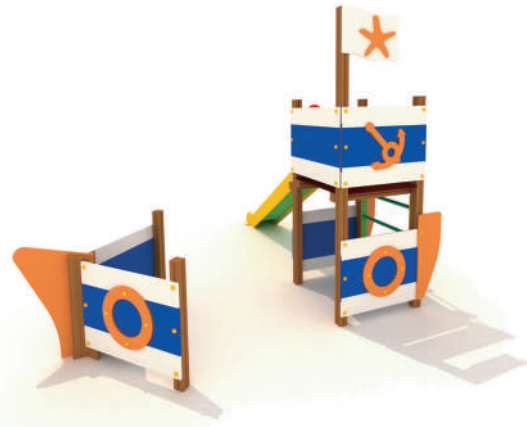

## BARCO 02

BAR-002



**1a12**

**DIM** 3,97 x 3,78m

 1,30m

**ZS** 6,99 x 6,28m



 5u.

**MDR**



## BARCO 03

BAR-003

<b>1a12</b>	<b>DIM</b>	11,51 x 4,53m
 1,30m	<b>ZS</b>	14,51 x 7,02m
 20u.	<b>MDR</b>	



## BARCO 04



BAR-004

<b>1a12</b>	<b>DIM</b>	13,69 x 4,53m
 1,30m	<b>ZS</b>	16,69 x 7,02m
 20u.	<b>MDR</b>	



## BARCO 05

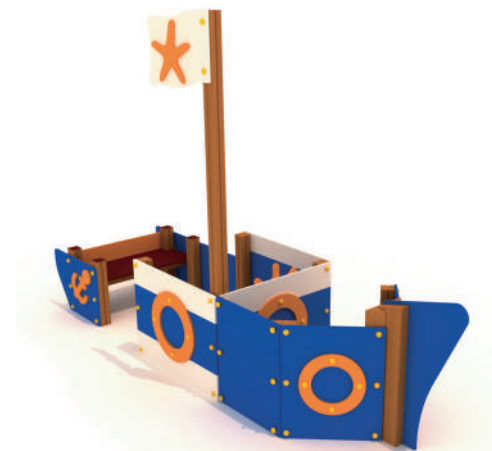

BAR-005

<b>1a5</b>	<b>DIM</b>	3,88 x 1,10m
 <0,60m	<b>ZS</b>	6,88 x 4,07m
 6u.	<b>MDR</b>	



## BARCO 06

BAR-006

<b>1a5</b>	<b>DIM</b>	3,88 x 1,10m
 <0,60m	<b>ZS</b>	6,88 x 4,07m
 6u.	<b>MDR</b>	

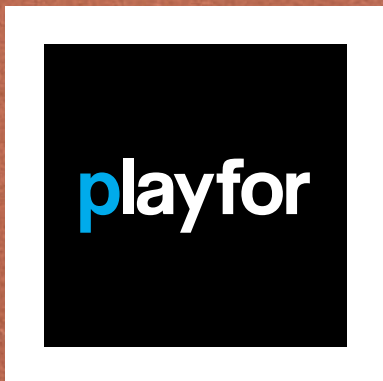

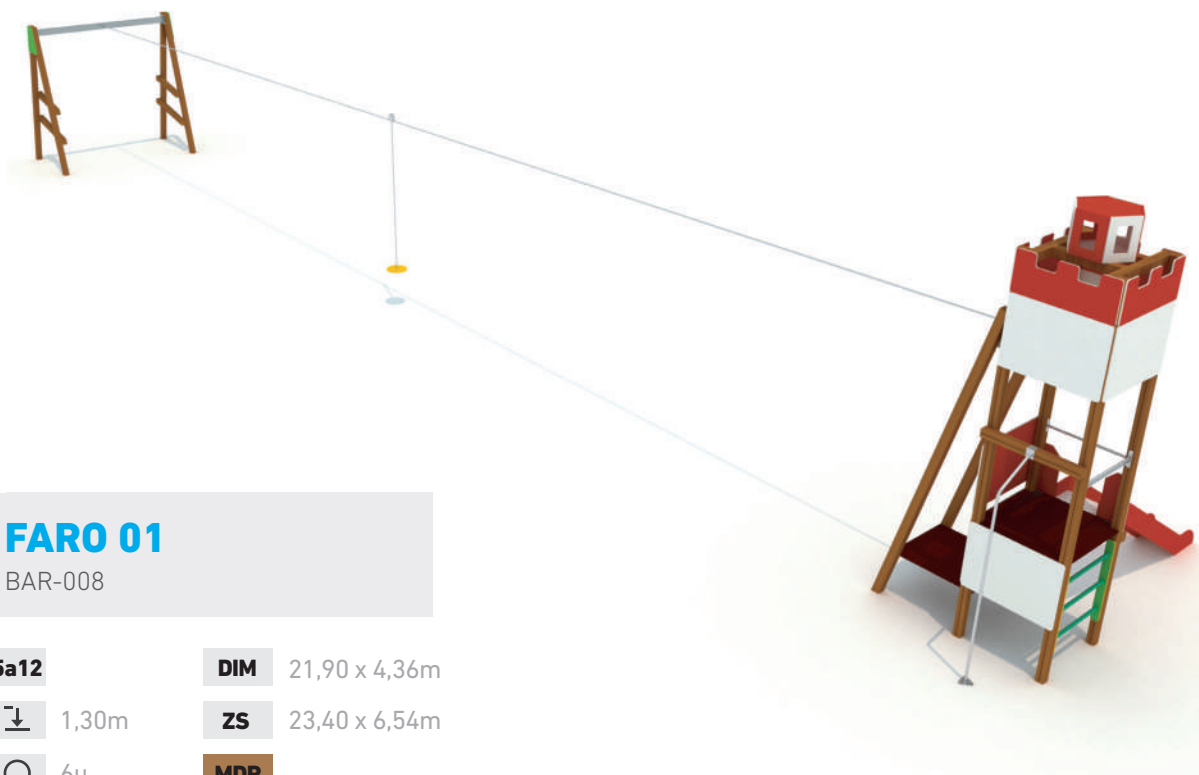

## FARO 01

BAR-008

**5a12**

**DIM** 21,90 x 4,36m

**↓** 1,30m

**ZS** 23,40 x 6,54m

**☉** 6u.

**MDR**

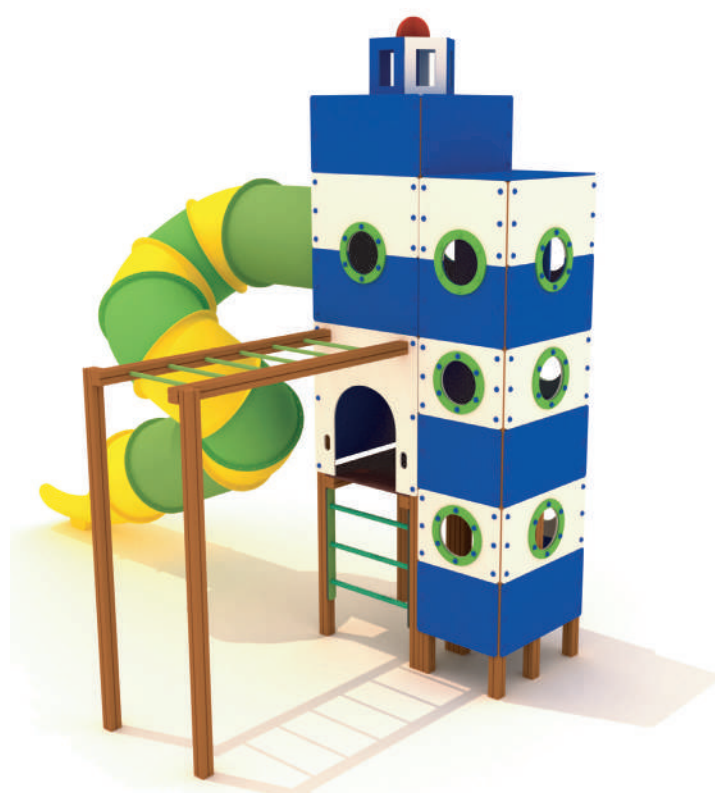

## FARO 02

BAR-009

**3a12**

**DIM** 3,86 x 3,68m

**↓** 1,30m

**ZS** 7,19 x 6,83m

**☉** 10u.

**MDR**



# PiNTA



## PINTA 01

PNT-001



**1a8**

0,90m

4u.

**DIM** 1,12 x 3,40m

**ZS** 3,80 x 5,90m

**MDR** **HRC** **GLV**



## PINTA 02

PNT-002



**1a8**

0,90m

6u.

**DIM** 2,27 x 3,40m

**ZS** 5,10 x 6,21m

**MDR** **HRC** **GLV**



### PINTA 03

PNT-003

1a8

**DIM** 3,96 x 3,40m

↓ 0,90m

**ZS** 5,24 x 7,16m

☉ 5u.

**MDR** **HRC** **GLV**



### PINTA 04

PNT-004

1a8

**DIM** 3,40 x 4,01m

↓ 0,90m

**ZS** 6,99 x 5,90m

☉ 10u.

**MDR** **HRC** **GLV**



### PINTA 05

PNT-005

1a8

**DIM** 3,00 x 3,40m

↓ 0,90m

**ZS** 5,79 x 5,90m

☉ 6u.

**MDR** **HRC** **GLV**

# SELVA





## SELVA 01

SEL-001

<b>1a8</b>	<b>DIM</b> 2,64 x 1,97m
0,90m	<b>ZS</b> 4,91 x 5,09m
4u.	<b>MDR</b> <b>HRC</b> <b>GLV</b>



## SELVA 02

SEL-002

<b>1a8</b>	<b>DIM</b> 3,20 x 2,66m
0,90m	<b>ZS</b> 6,20 x 5,09m
6u.	<b>MDR</b> <b>HRC</b> <b>GLV</b>



## SELVA 03

SEL-003

<b>1a8</b>	<b>DIM</b> 4,88 x 3,20m
0,90m	<b>ZS</b> 6,70 x 6,23m
5u.	<b>MDR</b> <b>HRC</b> <b>GLV</b>



## SELVA 04

SEL-004

<b>1a8</b>	<b>DIM</b> 4,01 x 3,40m
0,90m	<b>ZS</b> 6,99 x 5,90m
7u.	<b>MDR</b> <b>HRC</b> <b>GLV</b>

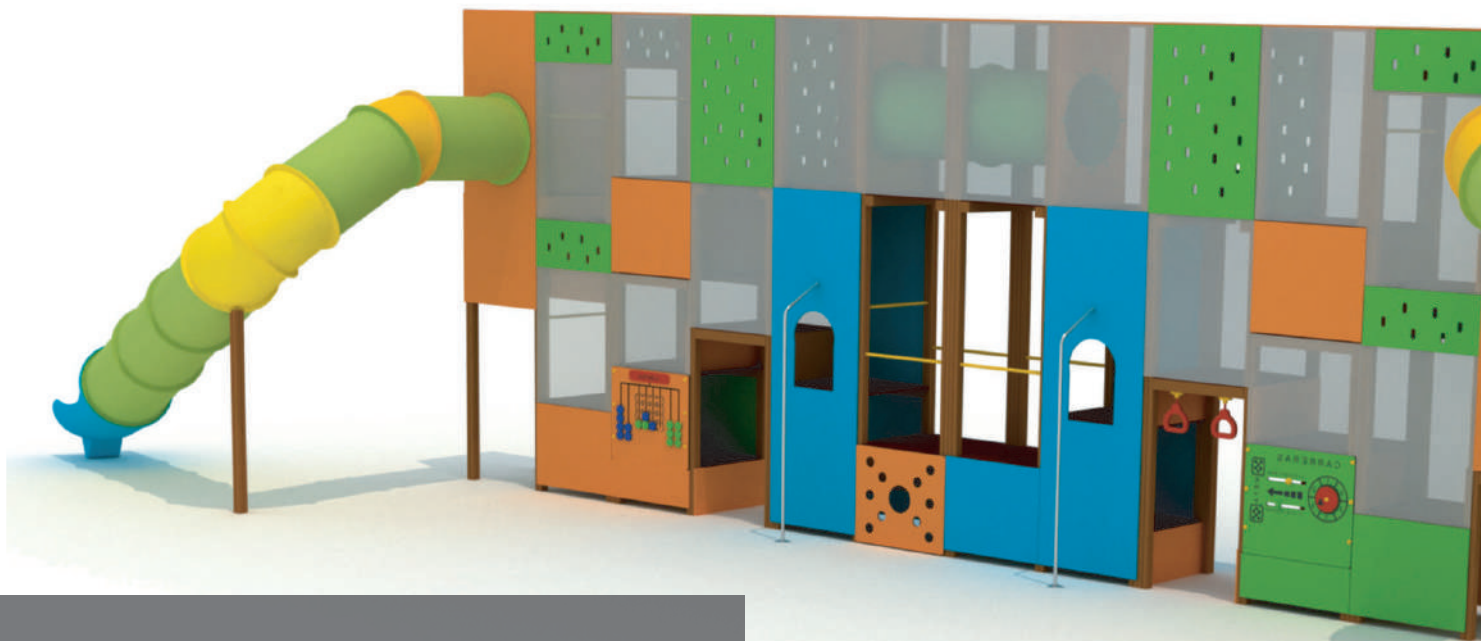

# CUBiC



## CUBIC 02

CUB-002



**5a12**



1,30m



12u.

**DIM**

11,34 x 3,61m

**ZS**

14,84 x 6,57m

**MDR**

**GLV**

**AL**



## CUBIC 01

CUB-001

5a12

↓ 1,30m

⌚ 25u.

**DIM** 21,17 x 4,07m

**ZS** 25,17 x 6,57m

**MDR** **GLV** **AL**

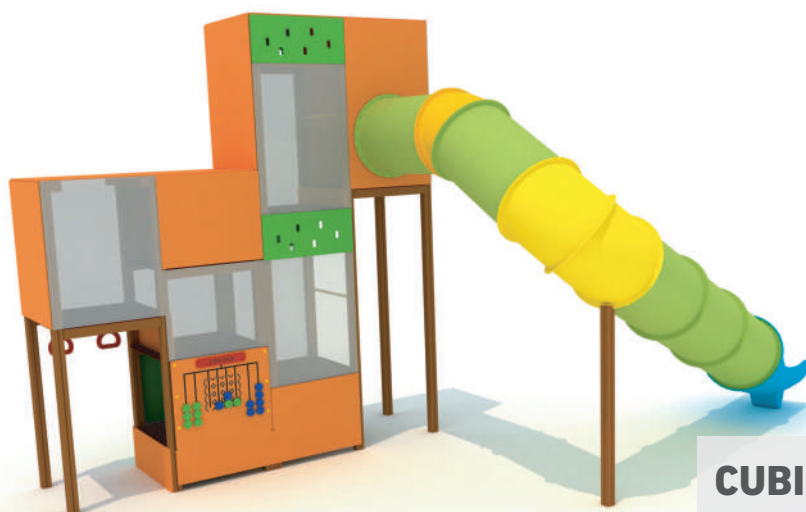

## CUBIC 03

CUB-003

5a12

↓ 2,00m

⌚ 10u.

**DIM** 7,86 x 4,09m

**ZS** 11,36 x 7,30m

**MDR** **GLV** **AL**



# GIGANTES



# CONFIGURA TU GIGANTE

Elige tu modelo preferido y configúralo según necesites. 1 sólo tobogán... o a lo mejor los 3 y tener un juego impresionante. Puede que 2 toboganes encaje mejor en el proyecto y permita añadir más elementos. **Lo probamos?**

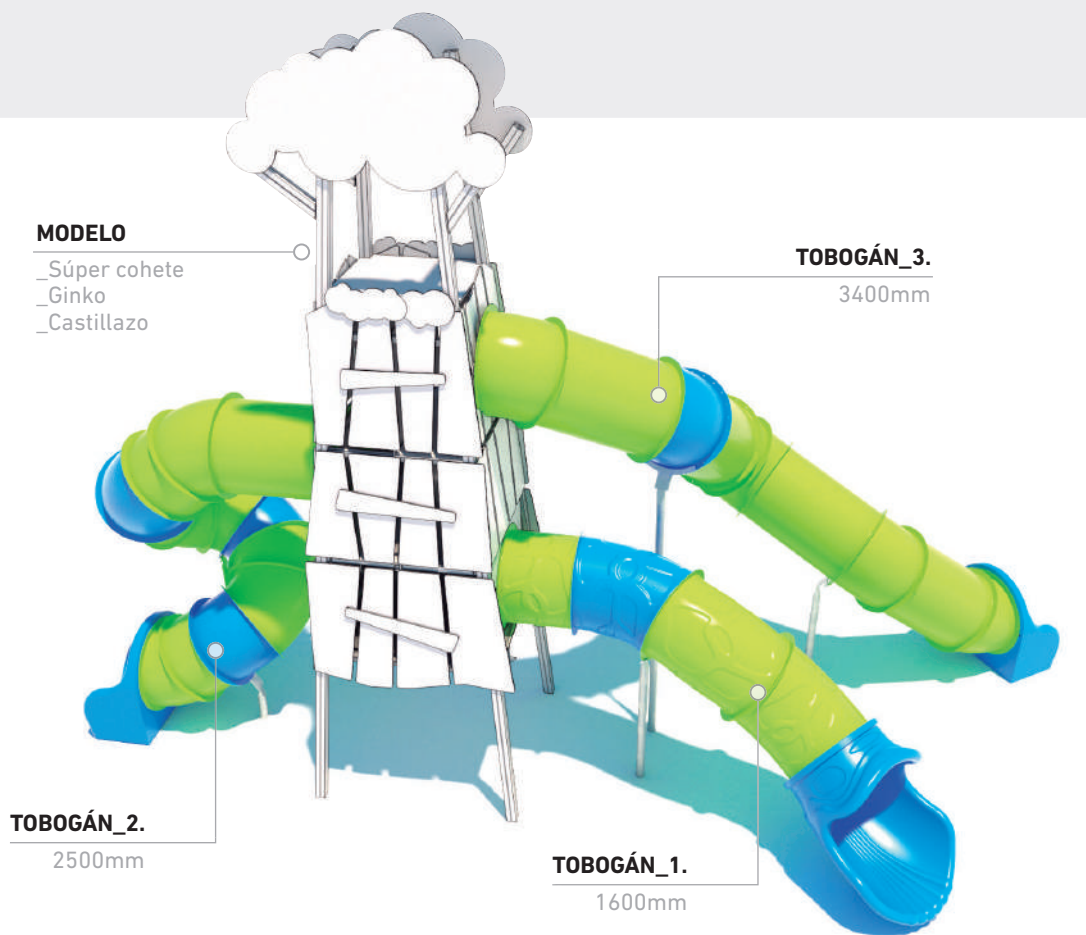

>6m!!!

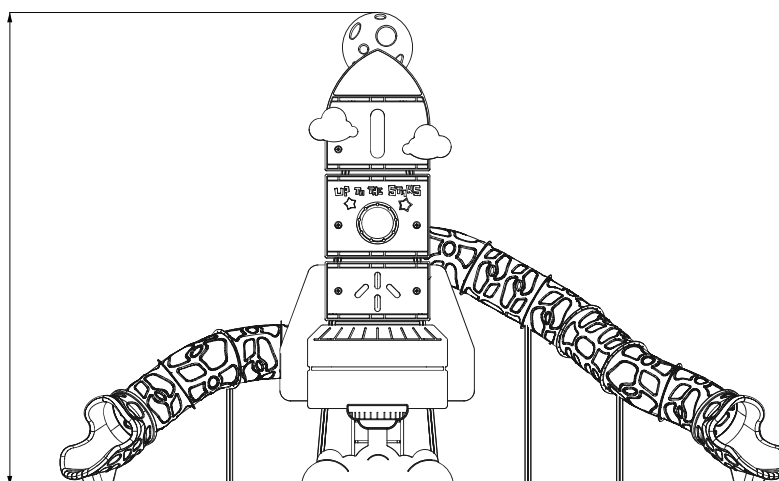

[ Las medidas indicadas son de la torre sin los toboganes. La zona de seguridad y medidas totales variarán según la cantidad y posición de toboganes ]

## SUPER COHETE

BIG-001

3a12

1,50m

12u.

**DIM** 1,80 x 1,80m

**ZS** 4,80 x 4,80m

**GLV** AL



## CASTILLAZO

BIG-003

3a12

**DIM** 1,80 x 1,80m

↓ 1,50m

**ZS** 4,80 x 4,80m

⊙ 12u.

**GLV** **AL**



## GINKO

BIG-002

3a12

**DIM** 1,80 x 1,80m

↓ 1,50m

**ZS** 4,80 x 4,80m

⊙ 12u.

**GLV** **AL**

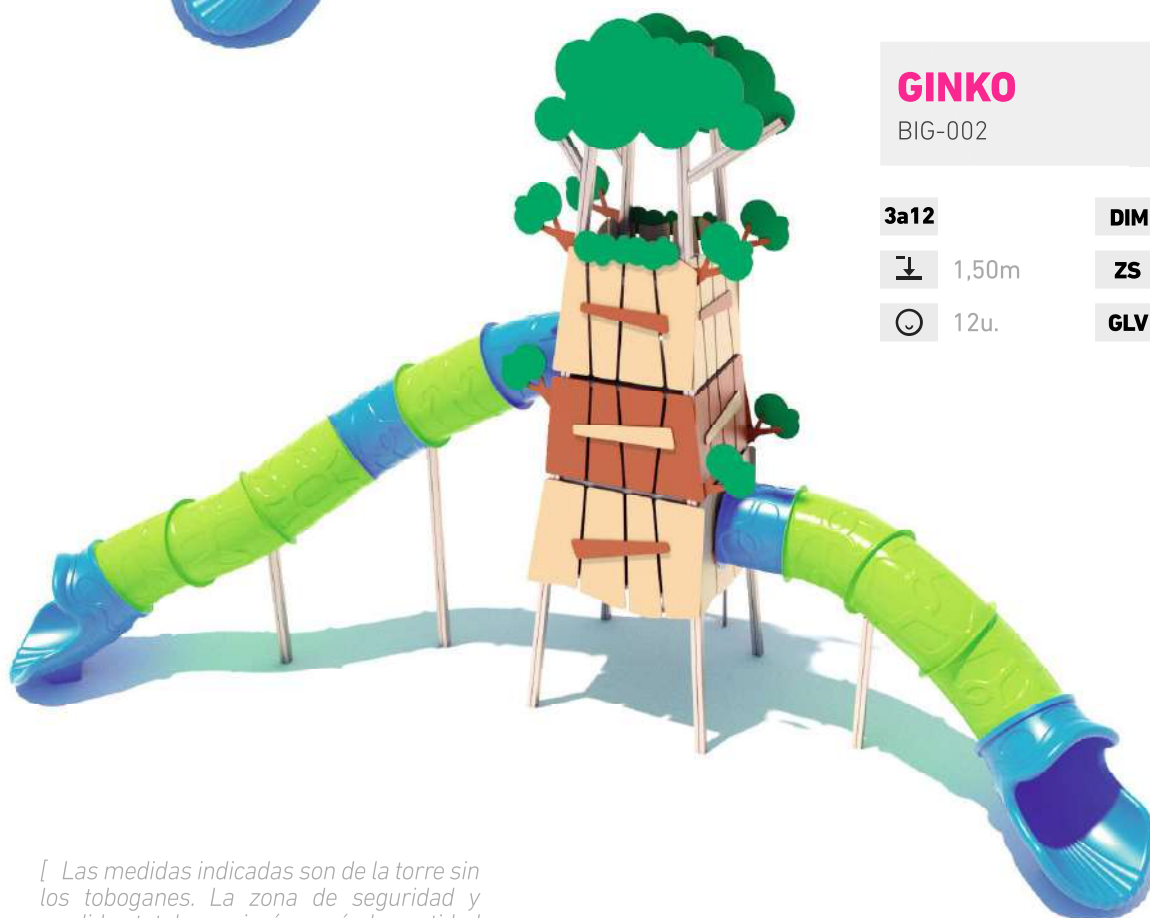

[ Las medidas indicadas son de la torre sin los toboganes. La zona de seguridad y medidas totales variarán según la cantidad y posición de toboganes ]

## GRAN MANÁ

BIG-004

3a12

↓ 1,50m

☉ 25u.

**DIM** 7,43 x 13,13m

**ZS** 9,80 x 16,15m

**GLV** **AL**

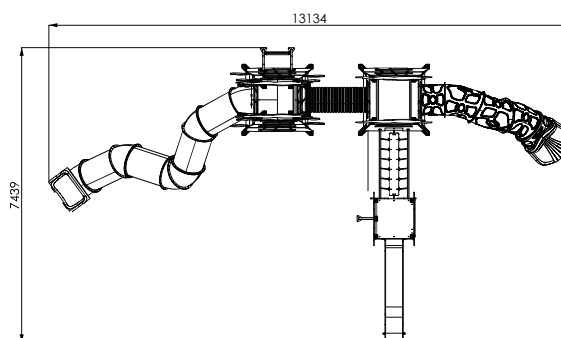
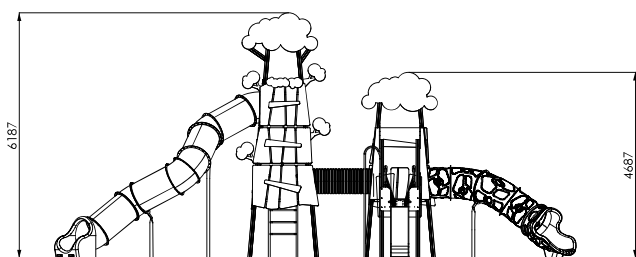
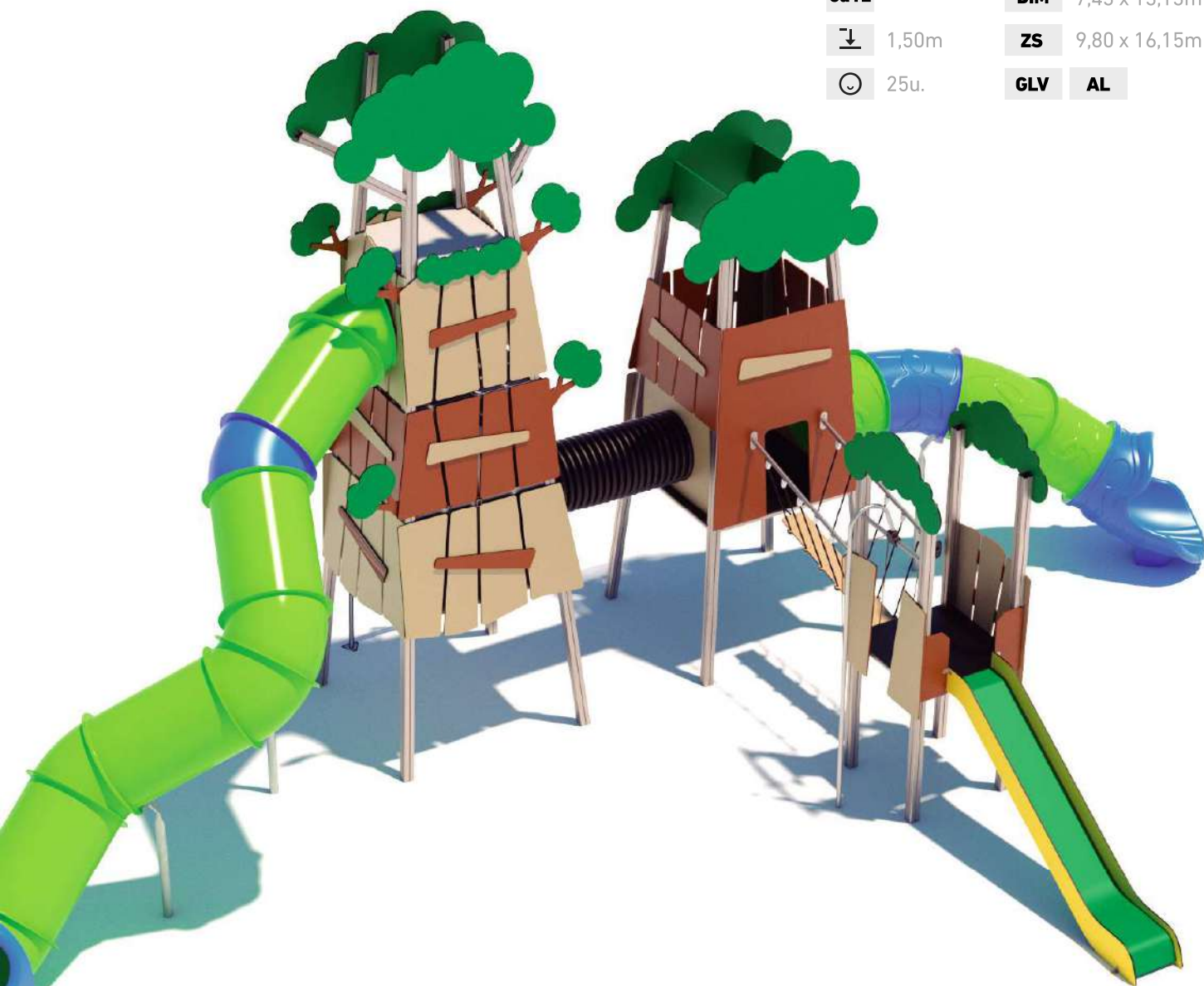

# INDEPENDIENTES

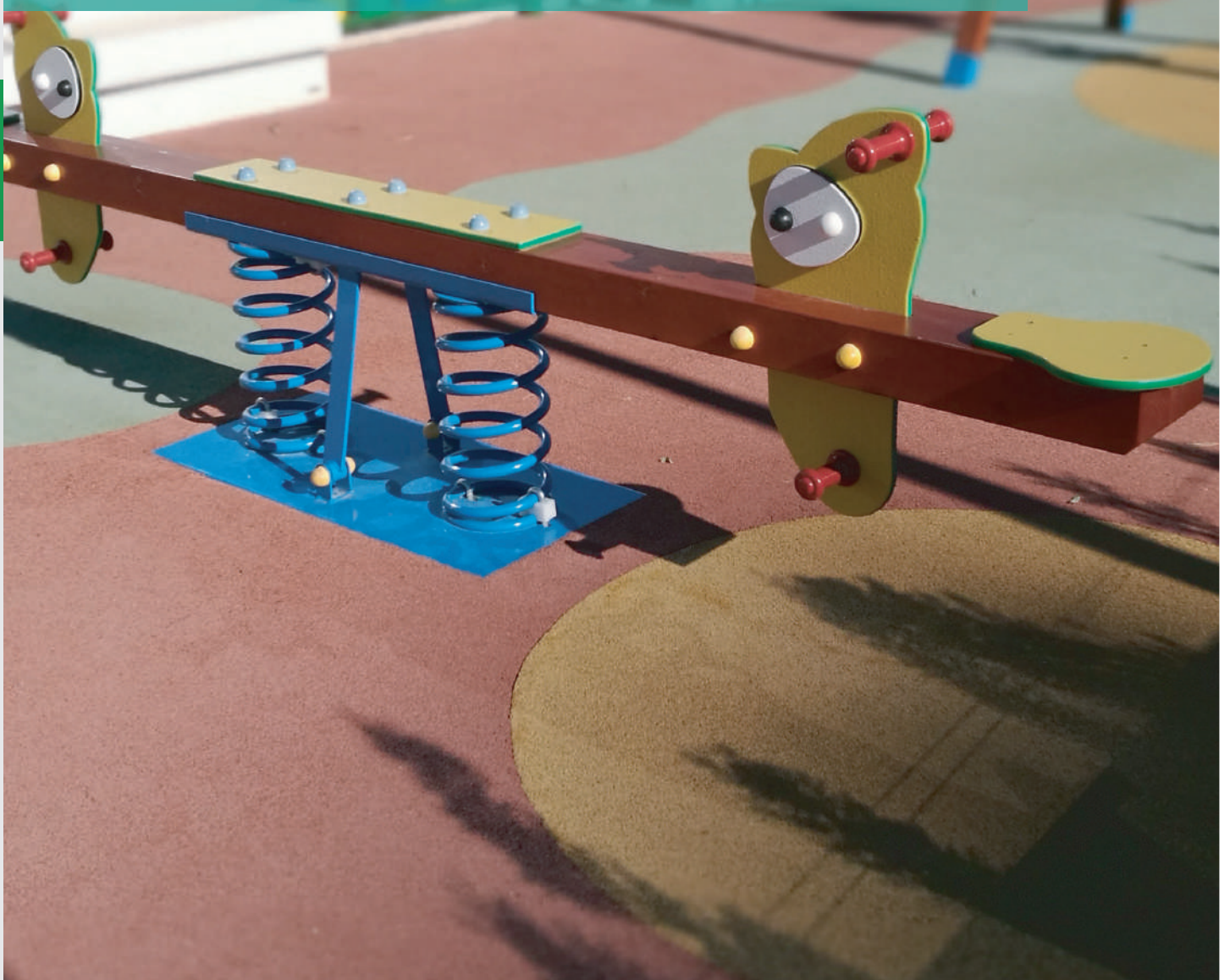

## PIRÂMIDE RED

RED-010

**1a8**

**DIM** □3,56 x 2,70m

**↓** 1,50m

**ZS** 5,55 x 5,55m

**⊙** 8u.

**GLV** **LAC**

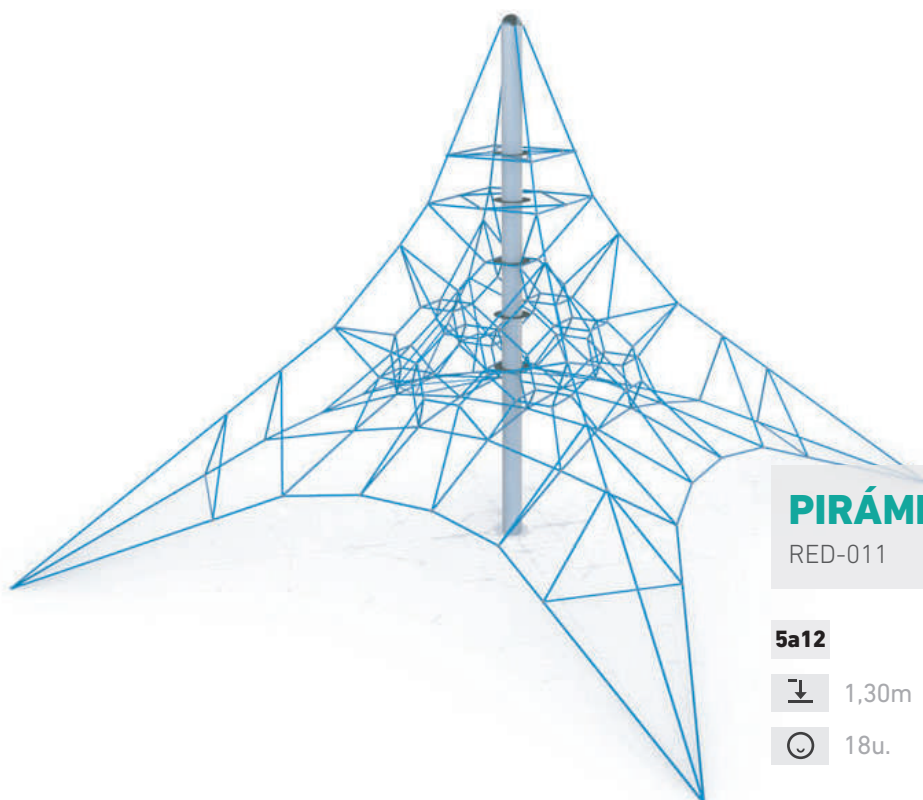
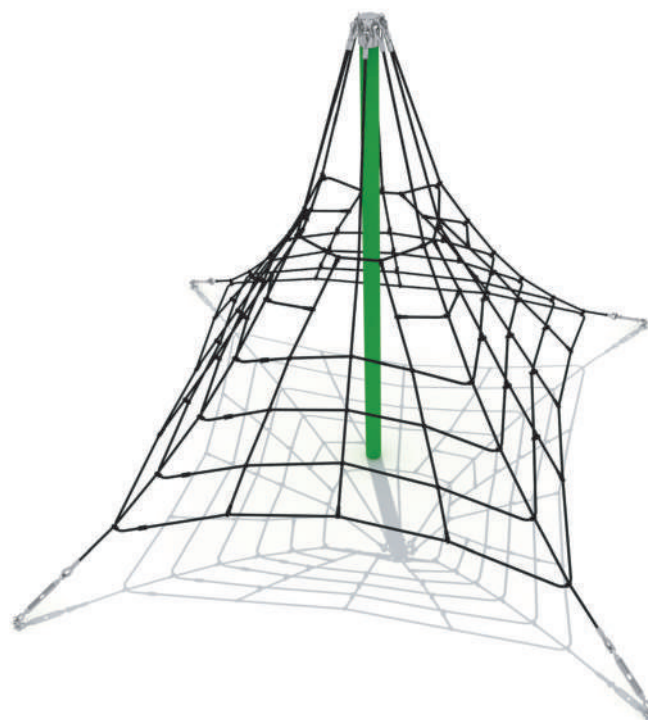

## PIRÂMIDE RED

RED-011

**5a12**

**DIM** □5,00 x 4,00m

**↓** 1,30m

**ZS** 8,00 x 8,00m

**⊙** 18u.

**GLV** **LAC**



## TIROLINA METÁLICA

TIR-001 | LARGO CABLE: 15m

**3a12**

**DIM** 18,10 x 1,72m



1,30m

**ZS** 18,10 x 4,00m



1u.

**GLV** **INOX**

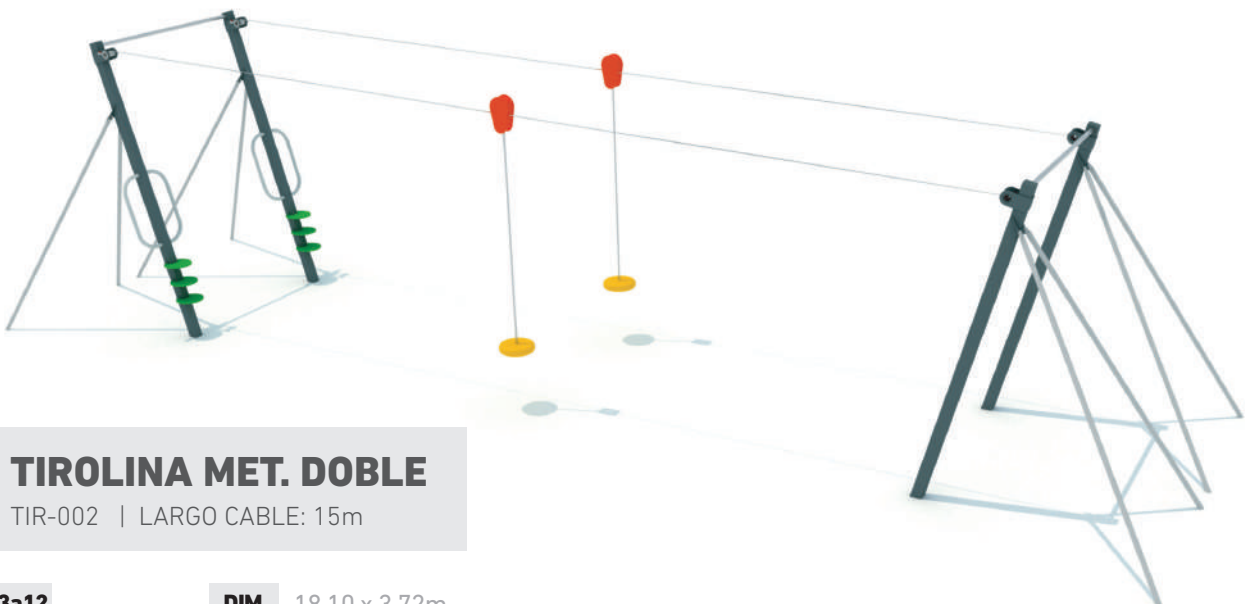

## TIROLINA MET. DOBLE

TIR-002 | LARGO CABLE: 15m

**3a12**

**DIM** 18,10 x 3,72m



1,30m

**ZS** 18,10 x 6,00m



2u.



**GLV** **INOX**

SE RECOMIENDA PERIMETRAR LA ZONA DE SEGURIDAD DE LAS TIROLINAS, O BIEN DIFERENCIAR EL SUELO DE SEGURIDAD MEDIANTE COLORES PARA INDICAR ZONA DE MOVIMIENTO / PELIGRO.



## TIROLINA TRIANGULAR 1P



TIR-004 | LARGO CABLE: 15m

<b>3a12</b>	<b>DIM</b>	18,63 x 1,15 x 3,24m
 1,30m	<b>ZS</b>	18,63 x 4,00m
 1u.	<b>GLV</b>	



## TIROLINA ROLLIZO

TIR-011D | LARGO CABLE: 20m

<b>3a12</b>	<b>DIM</b>	21,68 x 2,68m
 1,30m	<b>ZS</b>	22,90 x 4,00m
 1u.	<b>MDR</b>	

SE RECOMIENDA PERIMETRAR LA ZONA DE SEGURIDAD DE LAS TIROLINAS, O BIEN DIFERENCIAR EL SUELO DE SEGURIDAD MEDIANTE COLORES PARA INDICAR ZONA DE MOVIMIENTO / PELIGRO.



## MÁQUINA DE TREN

IND-004

<b>1a5</b>	<b>DIM</b> 1,79 x 1,00m
<0,6m	<b>ZS</b> 4,79 x 4,00m
5u.	<b>MDR</b> <b>HRC</b> <b>GLV</b>



## VAGÓN PASAJEROS

IND-005

<b>1a5</b>	<b>DIM</b> 1,68 x 1,00m
<0,6m	<b>ZS</b> 4,68 x 4,00m
6u.	<b>MDR</b> <b>HRC</b> <b>GLV</b>

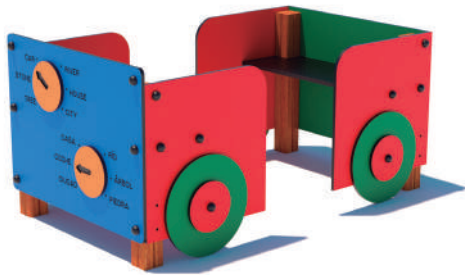

## VAGÓN

IND-006

<b>1a5</b>	<b>DIM</b> 1,61 x 1,00m
<0,6m	<b>ZS</b> 4,61 x 3,00m
6u.	<b>MDR</b> <b>HRC</b> <b>GLV</b>

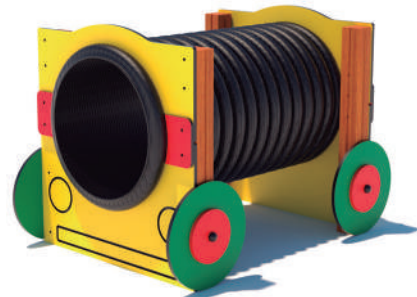

## VAGÓN CISTERNA

IND-007

<b>1a5</b>	<b>DIM</b> 1,00 x 1,00m
<0,6m	<b>ZS</b> 4,00 x 4,00m
6u.	<b>MDR</b> <b>HRC</b> <b>GLV</b>



**CONJUNTO TREN**



**TREN COMPLETO**

Imagen de tren anterior al fabricado actualmente.  
Valor informativo de colores y proporciones.



## CASITA PATIO

IND-001

**1a5**  <0,6m  5u.

**DIM** 1,07 x 2,22m **ZS** 4,1 x 5,22m



## CASITA NOMOS 01

NOM-001

**1a5**  <0,6m  4u.

**DIM** 1,02 x 1,03m **ZS** 4,2 x 4,1m



## CASITA ROCÓDROMO

IND-002

**1a5**  1,40m  6u.

**DIM** 1,43 x 2,47m **ZS** 5,5 x 4,1m



## CASITA CHAMPI

IND-003

**1a5**  <0,6m  2u.

**DIM** 1,63 x 0,94m **ZS** 4,7 x 4,0m



## NU20 01

NU2-001

**1a8**  <0,6m  4u.

**DIM** 1,02 x 1,03m **ZS** 4,0 x 3,95m



## NU20 02

NU2-002

**1a8**  <0,6m  6u.

**DIM** 3,20 x 1,02m **ZS** 6,1 x 4,1m



## CASITA BOSQUE

BOS-001

**1a5** <0,6m 4u.

**DIM** 1,88 x 1,00m **ZS** 3,9 x 3,1m



## CASITA ARGOS

ARG-012

**1a5** <0,6m 4u.

**DIM** 1,73 x 1,36m **ZS** 4,7 x 4,4m



## CASITA FRUTAS

FRU-007

**1a5** <0,6m 4u.

**DIM** 1,35 x 1,81m **ZS** 3,4 x 3,8m



## MOSSY CASITA

MOS-001

**1a5** <0,6m 8u.

**DIM** 3,36 x 2,78m **ZS** 5,3 x 4,8m



## HEXÁGONO

IND-008

**1a8** 1,40m 8u.

**DIM** 3,84 x 1,94m **ZS** 6,9 x 4,9m



## PUENTE

IND-015

**1a8** <0,6m 6u.

**DIM** 1,80 x 0,85m **ZS** 3,8 x 2,8m



### AVESTRUZ PEQ.

ANI-009

**1a5** ↓ 0,9m ☺ 2u.

**DIM** 2,63 x 0,55m **ZS** 5,2 x 3,5m



### AVESTRUZ

ANI-010

**3a12** ↓ 1,30m ☺ 2u.

**DIM** 3,25 x 0,55m **ZS** 5,7 x 3,5m

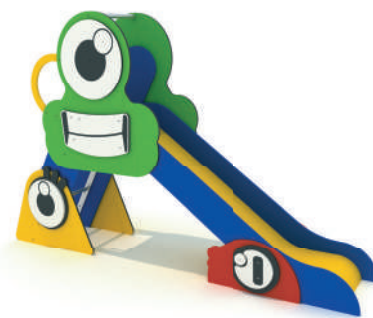

### TOBOG. MOSSY

TOB-008

**1a5** ↓ 0,90m ☺ 2u.

**DIM** 2,63 x 0,55m **ZS** 5,2 x 3,6m



### TOBOG. FRUTAS

FRU-009

**3a12** ↓ 0,90m ☺ 2u.

**DIM** 3,03 x 0,46m **ZS** 4,8 x 3,6m



### TOBOG. AVIÓN

AVI-003

**3a12** ↓ 1,30m ☺ 2u.

**DIM** 3,50 x 0,49m **ZS** 6 x 3,5m



### TOBOG. OLA

PIR-004

**1a5** ↓ <0,60m

**DIM** 2,75 x 0,83m **ZS** 5,8 x 3,9m

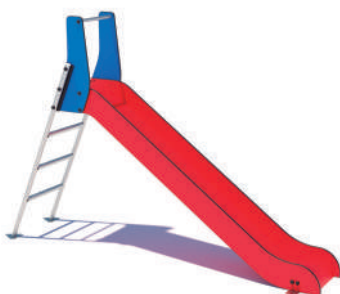

### TOBOG. 03

TOB-003

**3a12** ↓ 1,30m ☺ 2u.

**DIM** 3,03 x 0,46m **ZS** 5,5 x 3,5m



### TOBOG. 04

TOB-004

**1a5** ↓ 0,90m ☺ 2u.

**DIM** 2,6 x 0,46m **ZS** 4,8 x 3,5m



**TOBOG. INOX L**  
TOB-005

**3a12** ↓ 1,30m ☺ 2u.  
**DIM** 3,40 x 0,46m **ZS** 6 x 3,5m



**TOBOG. INOX S**  
TOB-006

**1a5** ↓ 0,90m ☺ 2u.  
**DIM** 2,73 x 0,46m **ZS** 5,3 x 3,5m

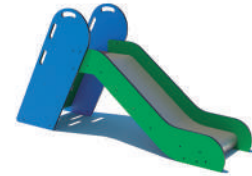

**TOBOG. INOX XS**  
TOB-110

**1a5** ↓ 0,60m ☺ 2u.  
**DIM** 1,94 x 0,49m **ZS** 4,2 x 3,5m

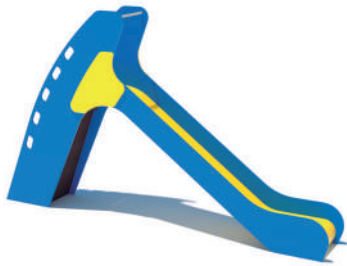

**TOBOG. PEHD L**  
TOB-001

**3a12** ↓ 1,30m ☺ 2u.  
**DIM** 3,40 x 0,46m **ZS** 6 x 3,5m



**TOBOG. PEHD S**  
TOB-002

**1a5** ↓ 0,90m ☺ 2u.  
**DIM** 2,73 x 0,46m **ZS** 5,3 x 3,5m



**TOBOG. PEHD XS**  
TOB-111

**1a5** ↓ 0,60m ☺ 2u.  
**DIM** 2,2 x 0,46m **ZS** 4,3 x 3,5m

TOBOGÁN **FULL-HDPE**  
LENGUA HDPE 15mm

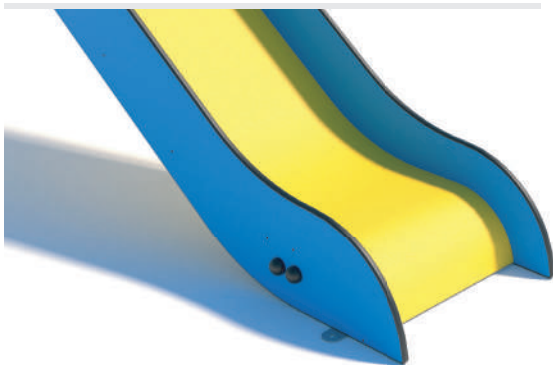

LENGUA INOX 2mm  
LATERALES HDPE

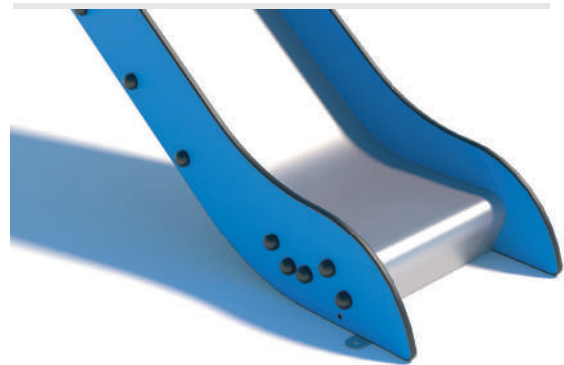



### DOBLE

COL-001

3a12 ↓ 1,34m ☺ 2u.



### BABY DOBLE

COL-002

1a5 ↓ 1,34m ☺ 2u.



### BABY

COL-003

1a5 ↓ 1,34m ☺ 1u.



### MIXTO

COL-004

1a12 ↓ 1,34m ☺ 2u.



### DOBLE MET.

COL-005

3a12 ↓ 1,34m ☺ 2u.



### BABY DOBLE MET.

COL-006

1a5 ↓ 1,34m ☺ 2u.



### MIXTO MET.

COL-007

1a12 ↓ 1,34m ☺ 2u.



### TUB. DOBLE

COL-008

3a12 ↓ 1,34m ☺ 2u.



### TUB. BABY DOBLE

COL-009

1a5 ↓ 1,34m ☺ 3u.



### TUB. MIXTO

COL-010

1a12 ↓ 1,34m ☺ 2u.



### PENTÁGONO

COL-011

1a12 ↓ 1,34m ☺ 5u.



### TRIPLE PÓRTICO

COL-012

1a12 ↓ 1,34m ☺ 8u.



### TLN 2

TLN-014

3a12 ↓ 1,34m ☺ 2u.



### TLN MIX

TLN-014C

3a12 ↓ 1,34m ☺ 2u.



### TLN MIX2

TLN-014D

1a12 ↓ 1,34m ☺ 2u.



### NIDO

TLN-002

3a12 ↓ 1,40m ☺ 4u.



### NIDO METÁLICO

TLN-002M

3a12 ↓ 1,40m ☺ 4u.



### FRUTAS

FRU-008

1a12 ↓ 1,34m ☺ 2u.



### ARDILLA

ANI-011

3a12 ↓ 1,34m ☺ 2u.



### MOSSY

COL-016

3a12 ↓ 1,34m ☺ 2u.



### TRIPLE

COL-015

3a12 ↓ 1,40m ☺ 6u.

### PLANO

ACC-901



### BEBÉ

ACC-902



### NIDO

ACC-903



### INCLUSIVO

ACC-905



### DUO

ACC-906





### MOTO CLÁSICA

BAL-001

3a12 <0,6m 1u.



### PERRO

BAL-002

3a12 <0,6m 1u.



### CONEJO

BAL-003

3a12 <0,6m 1u.



### CABALLO

BAL-004

3a12 <0,6m 1u.



### COCHECITO

BAL-005

3a12 <0,6m 1u.



### JIRAFÁ

BAL-006

3a12 <0,6m 1u.



### PEZ

BAL-007

3a12 <0,6m 1u.

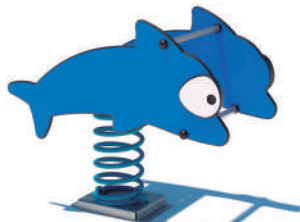

### DELFIN

BAL-008

3a12 <0,6m 1u.



### CANGREJO

BAL-009

3a12 <0,6m 1u.



### ESTRELLA

BAL-010

3a12 <0,6m 4u.



### AVIÓN

BAL-011

3a12 <0,6m 1u.



### SCOOTER

BAL-023

3a12 <0,6m 1u.



## FURGONETA

BAL-014

3a12 <0,6m 1u.



## AMBULANCIA

BAL-027

3a12 <0,6m 1u.



## TRACTOR

BAL-032

3a12 <0,6m 1u.



## MONSTRUO FLI

BAL-012

3a12 <0,6m 1u.



## MONSTRUO FLA

BAL-013

3a12 <0,6m 1u.



## COHETE

BAL-042

3a12 <0,6m 1u.



## PUNK

BAL-036

3a12 <0,6m 1u.



## FLEQUI

BAL-037

3a12 <0,6m 1u.



## ROCK

BAL-038

3a12 <0,6m 1u.

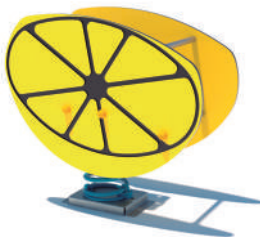

## LIMÓN

BAL-024

3a12 <0,6m 1u.



## PERA

BAL-025

3a12 <0,6m 1u.



## NARANJA

BAL-026

3a12 <0,6m 1u.

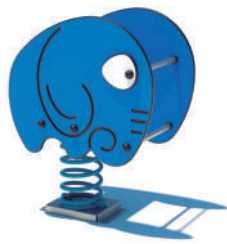

## ELEFANTE

BAL-028

3a12 ↓ <0,6m ○ 1u.



## LEÓN

BAL-029

3a12 ↓ <0,6m ○ 1u.



## PANDA

BAL-030

3a12 ↓ <0,6m ○ 1u.

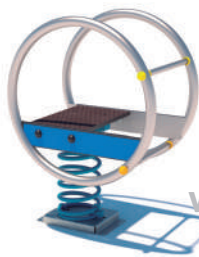

ANTI  
VANDÁ  
LICO

## REDONDO

BAL-015

3a12 ↓ <0,6m ○ 1u.



ANTI  
VANDÁ  
LICO

## CUADRADO

BAL-016

3a12 ↓ <0,6m ○ 1u.



ANTI  
VANDÁ  
LICO

## TRIÁNGULO

BAL-017

3a12 ↓ <0,6m ○ 1u.



## MICONE

BAL-021

3a12 ↓ <0,6m ○ 2u.



## HAPPY

BAL-039

3a12 ↓ <0,6m ○ 2u.



## BALÓN

BAL-021B

3a12 ↓ <0,6m ○ 2u.



## BANDERA

PIR-025

3a12 ↓ <0,6m ○ 1u.



## PIRATA

PIR-026

3a12 ↓ <0,6m ○ 1u.



## BALSA

PIR-003

1a5 ↓ <0,6m ○ 2u.



### BARCO

BAL-031

3a12 <0,6m 1u.



### BARCO R

BAL-031A

3a12 <0,6m 1u.

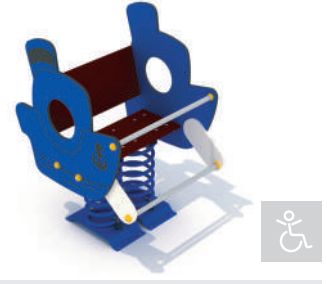

### BARCO R-2P

BAL-031B

3a12 <0,6m 2u.



### LEÓN

BAL-047

3a12 1u.

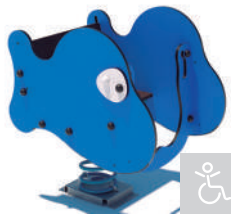

### BALLENA

BAL-046

3a12 1u.



### BALÓN

BAL-048

3a12 1u.



### CANGREJO

BAL-049

3a12 1u.



### BALANCÍN MICO 2

BAL-018

3a12 <0,6m 2u.

MDR GLV

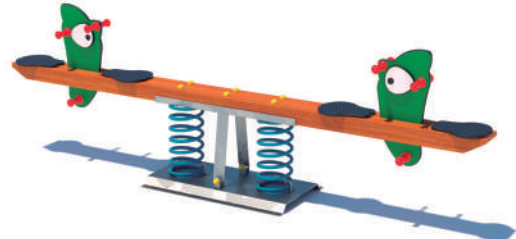

### BALANCÍN MICO 4

BAL-020

3a12 <0,6m 4u.

MDR GLV



### BALANCÍN EMOTICONO

BAL-020A

3a12 <0,6m 4u.

MDR GLV



### BALANCÍN PANDA

BAL-044

3a12 <0,6m 4u.

GLV

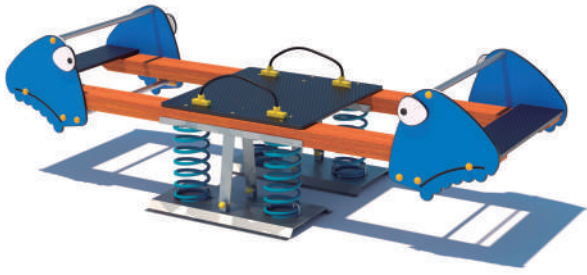

## BALANCÍN BIG

BAL-019

3a12  <0,6m  6u.



## BALANCÍN TRIPLE

BAL-040

3a12  <0,6m  3u.

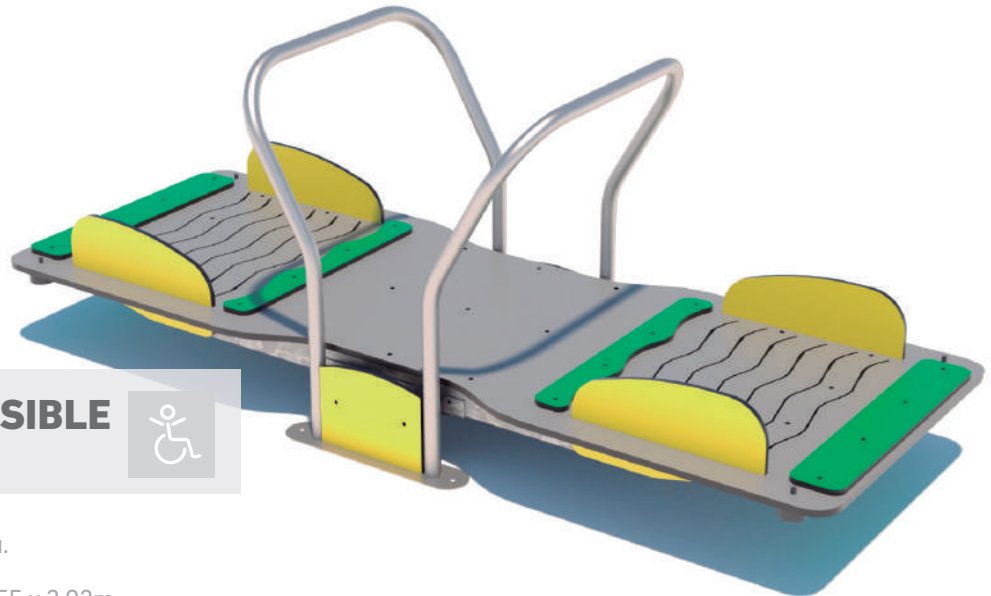

## BALANCÍN ACCESIBLE

TLN-003



3a12  0,60m  2u.

**DIM** 2,55 x 0,92m **ZS** 5,55 x 3,92m

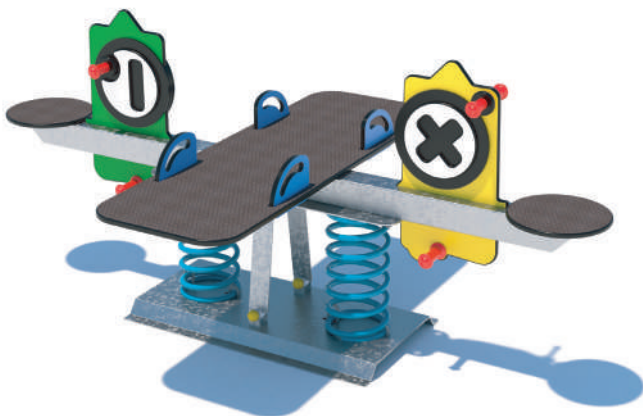

## BALANCÍN 4P MOSSY

BAL-052

3a12  0,60m  4u.

**DIM** 2,14 x 1,36m **ZS** 4,14 x 4,35m

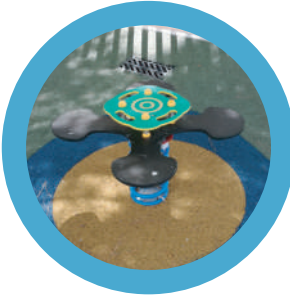

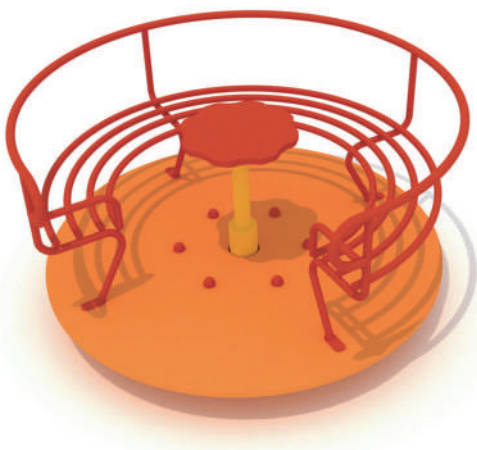

## CARRUSEL

ACC-009F

**3a8**

**DIM** Ø1,30m

**↓** <0,60m

**ZS** Ø5,30m

**☉** 6u.

**LAC** **GLV**

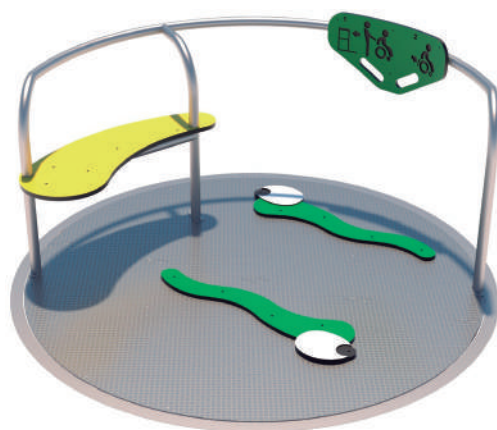

## CARRUSEL ACCES.

ACC-015



**1a5**

**DIM** Ø1,90m

**↓** 0,78m

**ZS** Ø5,90m

**☉** 6u.

**INOX** **GLV**

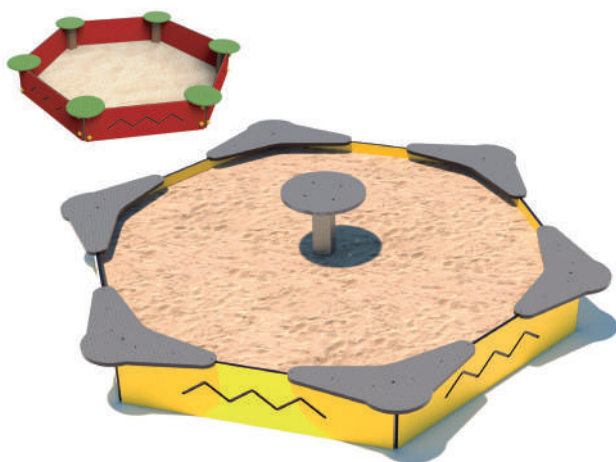

## ARENERO MESA

ACC-010 / ACC-016



**1a5**

**DIM** 2,16 x 2,07m

**↓** <0,60m

**ZS** 5,16 x 5,07m

**☉** 10u.

**MDR** **HRC** **GLV**

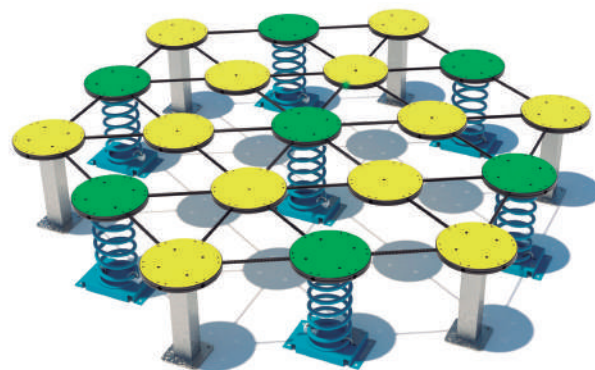

## MUELLE EQUILIBRIO

ACC-013



**3a12**

**DIM** Ø2,86m

**↓** <0,60m

**ZS** 5,86 x 5,53m

**☉** 10u.

**MDR** **GLV**

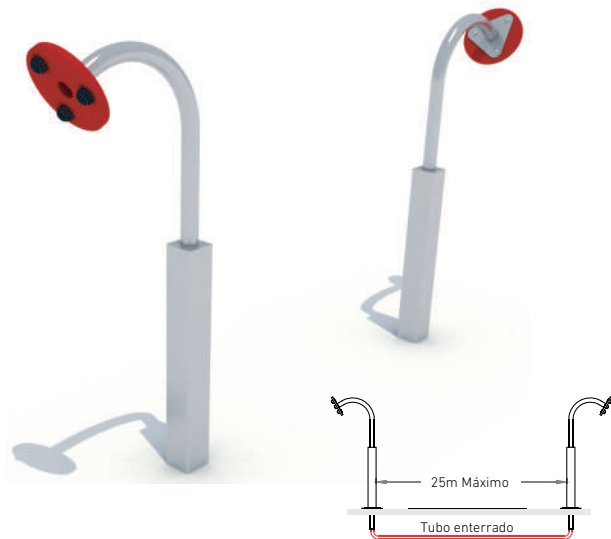

## TELÉFONO

ACC-030

**3a12**

**DIM** 25m máx.



-

**ZS** -



2u.

**INOX GLV**



## PALMERA

ACC-012

**1a5**

**DIM** 1,60 x 1,60m



**ZS**



**MDR LAC**



## ZIG ZAG

PIP-020



**1a8**

**DIM** 3,23 x 2,91m



<0,6m

**ZS** 6,11 x 5,91m



10 u.

**MDR HRC GLV**

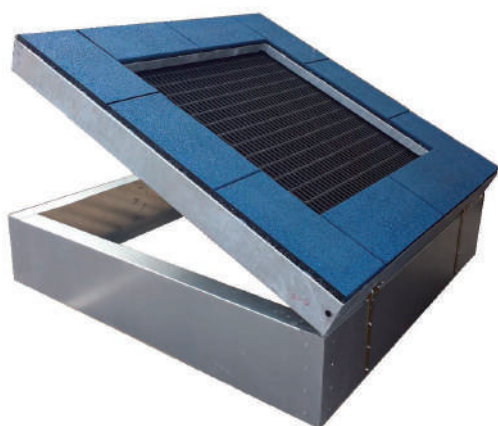

## CAMA ELÁSTICA

ACC-031 / 035

**3a12**

ACC-031

**↓** 1,0m      **DIM** 1,5 x 1,5m

**A.S.** 1,0 x 1,0m      **ZS** 4,0 x 4,0m

ACC-032

**↓** 1,0m      **DIM** 1,75 x 1,5m

**A.S.** 1,25 x 1,0m      **ZS** 4,25 x 4,0m

ACC-033

**↓** 1m      **DIM** 2,0 x 2,0m

**A.S.** 1,5 x 1,5m      **ZS** 5,5 x 5,5m

ACC-034

**↓** 1m      **DIM** 3,0 x 2,0m

**A.S.** 2,5 x 1,5m      **ZS** 6,5 x 5,5m

ACC-035

**↓** 1m      **DIM** 2,5 x 2,5m

**A.S.** 2,0 x 2,0m      **ZS** 6,0 x 6,0m





## ALTURA

PIP-001



## TRADUCTOR

PIP-002



## 3 EN FILA

PIP-003



## SOPA LETRAS

PIP-004



## CARRERAS

PIP-005



## CIRCUITO

PIP-006



## LABERINTO

PIP-007



## SIGNOS

PIP-008



## RELOJ

PIP-009

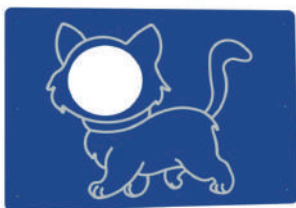

## GATO

PIN-010A



## LEÓN

PIN-010B



## PERRO

PIN-010C

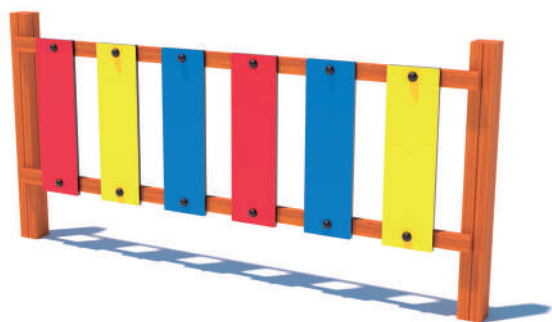

**MADERA MULTICOLOR**  
ACC-001C

↑ 0,89m ↔ 2,00m (entre ejes) **MDR**

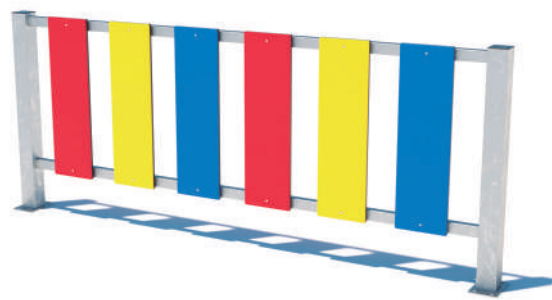

**GALVAN. MULTICOLOR**  
ACC-002

↑ 0,82m ↔ 1,98m (entre ejes) **GLV**



**METÁLICA MULTICOLOR**  
ACC-003

↑ 0,81m ↔ 2,00m (entre ejes) **LAC**



70% Cáscara de arroz  
30% HDPE reciclado

**COMPAKT HRC**  
ACC-011

↑ 0,96m ↔ 2,00m (entre ejes) **HRC**





## PUERTA MAD. MULTICOLOR

PUE-001C

**DIM** 1,00 x 0,89m (puerta)

**MDR**



## PUERTA GALV. MULTICOLOR

PUE-002

**DIM** 1,00 x 0,82m (puerta)

**GLV**

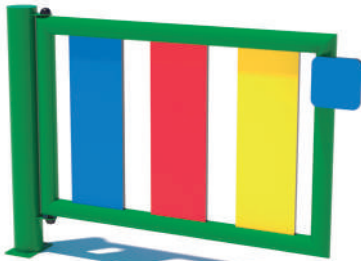

## PUERTA MET. MULTICOLOR

PUE-003

**DIM** 1,00 x 0,81m (puerta)

**LAC**



## PUERTA COMPAKT 01

PUE-011

**DIM** 1,00 x 0,96m (puerta)

**LAC**



## ESTÁNDAR

ACC-020 /021 (sin poste)

**DIM** 0,75 x 0,70m



## CARTEL ÁRBOL

ACC-022

**DIM** 0,94 x 0,98m



## CARTEL PIRATA

ACC-023

**DIM** 1,09 x 1,25m



## CARTEL ÁREA

ACC-024

**DIM** 1,07 x 0,87m

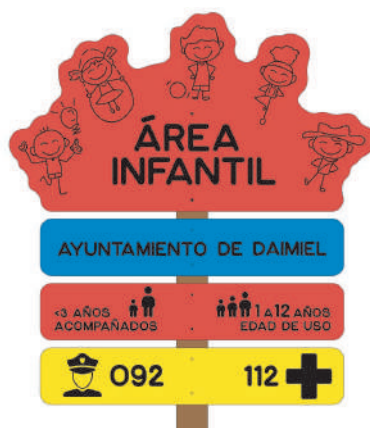

## CARTEL NIÑOS

ACC-025

**DIM** 0,96 x 1,03m



**AJEDREZ M1**  
ACC-005



**DIM** 2,10 x 0,60m



**PARCHÍS M1**  
ACC-006

**DIM** 2,10 x 2,10m



**AJEDREZ M2**  
ACC-007



**DIM** 1,70 x 0,60m

**MDR** **GLV** **AL**



**PARCHÍS M1**  
ACC-008

**DIM** 1,70 x 1,70m

**MDR** **GLV** **AL**

**OPCIÓN PANELES**

| PARCHÍS

| JUEGO DE LA OCA

| AJEDREZ

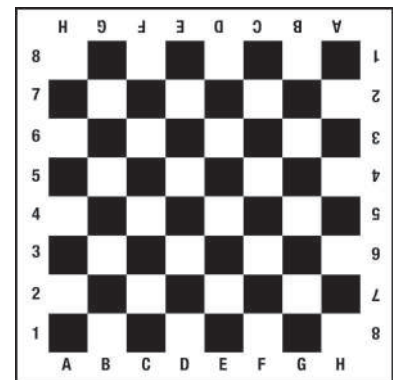
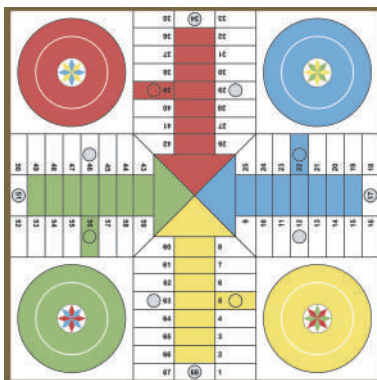

# SEGURIDAD Y DISEÑO

## SUELOS

Disponemos de nuestra propia sección de instalaciones, realizando obras completas o la fabricación o instalación de la partida de proyecto necesaria. Por eso, complementamos nuestra oferta de parques, mobiliario urbano y elementos deportivos con la instalación de suelos, ya sean decorativos o de seguridad.

Contamos con nuestra propia división de fabricación de losetas de caucho, con modelos certificados bajo normativa vigente, así como opciones de suelo continuo.

Nuestro objetivo es el de brindar un servicio integral, de inicio a fin, y de complementar nuestra oferta para ayudar a ofrecer experiencias de zonas urbanas completas.

# flexifor

ELIGE EL TIPO DE SUELO



ELIGE EL DISEÑO Y COLORES



CONFIRMA m2



INSTALACIÓN

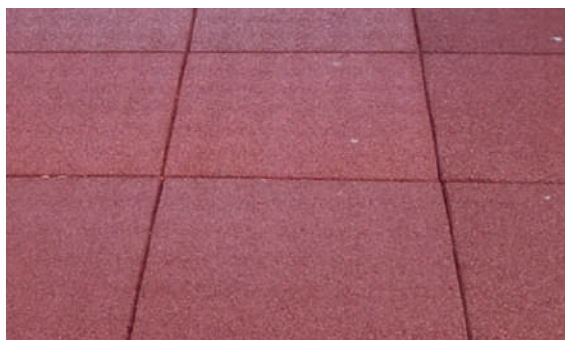

## LOSETA 43mm

Fabricada en nuestras instalaciones, de 0,5x1m de formato, con instalación mediante clipado y pegado.

Disponible en 3 colores y con posibilidad de biselados de terminación.

Con certificación vigente para una altura de caída de 1,30m



## SUELO CONTINUO

Opción de suelo tanto en EPDM como ENCAPSULADO, con espesor adaptado a la necesidad del proyecto.

Gran disponibilidad de colores y adaptación de formas y colores.



## PLAYGRASS

Césped artificial anti estático de 25mm, con instalación recomendada sobre base acolchada.

Con hasta 5 colores a elegir, opción muy vistosa y de bajo mantenimiento.



## ALFOMBRA DE PIEDRA

Alfombra de piedra decorativa continua, adaptada a cualquier zona y forma, con variedad de colores.

Acabado premium para zonas comunes

# LOSETA 43mm

LCA-003 verde  
LCA-004 roja  
LCA-006 negra

↓ 1,30m

DIM 0,50 x 1,00m

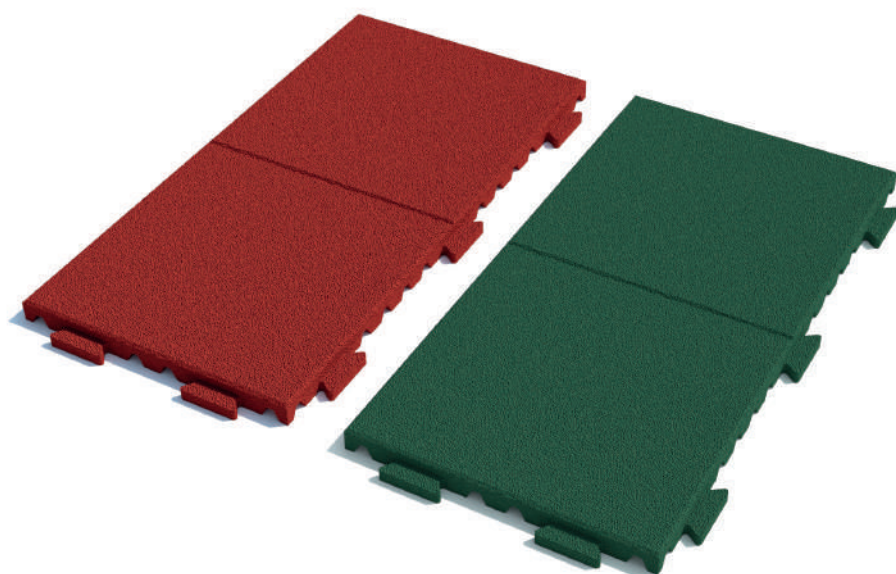

HASTA 100% RECICLADO  
UP TO RECYCLED 100%

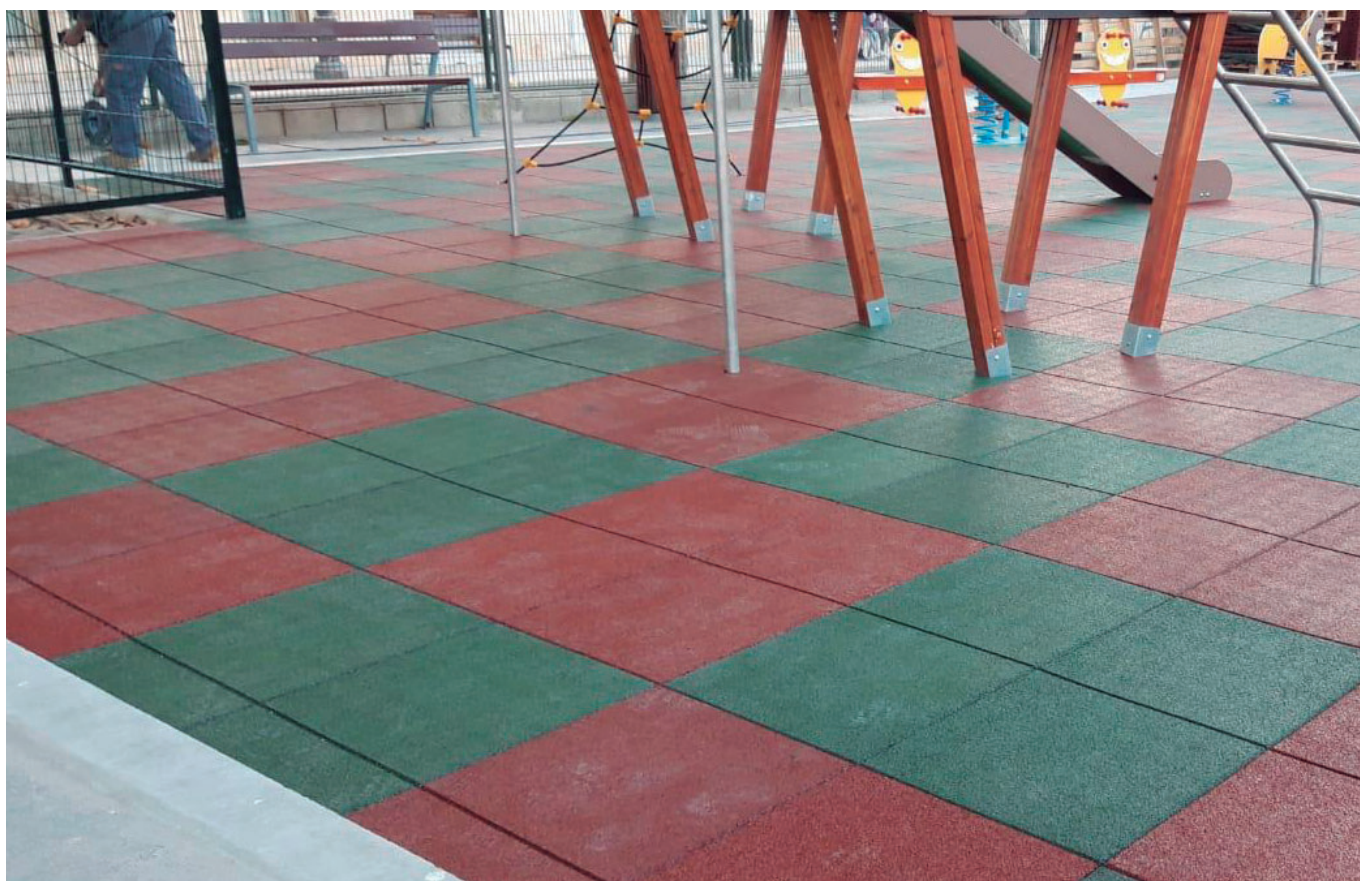
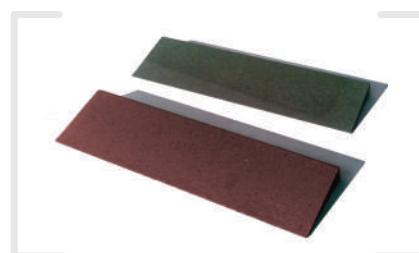

# EPDM / ENCAPSULADO

CCA-001 - SUELO CONTINUO EPDM

CCA-002 - SUELO CONTINUO ENCAPSULADO

■  
*Opción 3+1cm y 4+1cm para ambos modelos según A.C.L de los juegos*



# PLAYGRASS

COMPOSICIÓN	PE antiestático / PP en rizo
TIPO	Monofilamento
DTEX	11.500
ALTURA	25mm
GALGA	3/8"
PUNTADAS/m <sup>2</sup>	21.000
PESO DE FIBRA	1.400 g/m <sup>2</sup>
PESO DE PRODUCTO	2.400 g/m <sup>2</sup>
BASE PRIMARIA	Polipropileno



**AZUL**



**VERDE**



**NARANJA**



**ROJO**



**VIOLETA**

The logo for 'playfor' is displayed in a black square with a white border. The word 'playfor' is written in a lowercase, sans-serif font, with 'play' in white and 'for' in blue.

CÉSPED ARTIFICIAL

ENCAPSULADO

# ALFOMBRA DE PIEDRA

El sistema ALFOMBRA PIEDRA FLEXIFOR que hemos desarrollado es una solución continua para el revestimiento decorativo de suelos, diseñada para su aplicación tanto en espacios interiores como exteriores.

Consiste en una capa continua de pequeño espesor, comprendido entre 1 y 2 cm, formada por áridos naturales de granulometría controlada, ligados mediante una resina sintética específica. El resultado es un pavimento sin juntas, de aspecto natural y gran adaptabilidad a distintos entornos y usos.

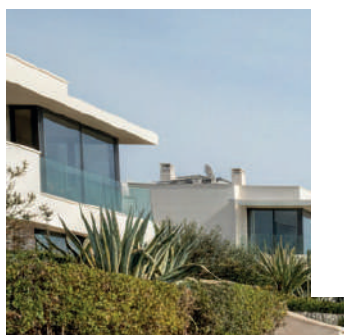

Gracias a sus características técnicas, ALFOMBRA PIEDRA FLEXIFOR puede instalarse en una amplia variedad de espacios, tales como zonas residenciales, locales comerciales, oficinas, terrazas, solárium, accesos peatonales, baños, cocinas, centros asistenciales, azoteas, paseos exteriores y áreas perimetrales de piscinas, entre otros.

Desde el punto de vista funcional, se trata de un pavimento duradero y resistente al desgaste, con buena resistencia superficial al rayado y estabilidad cromática a lo largo del tiempo. Es compatible con diferentes tipos de soportes, incluyendo soleras de hormigón, pavimentos cerámicos existentes y superficies asfálticas, así como con sistemas de calefacción por suelo radiante. Su mantenimiento resulta sencillo y presenta propiedades antialérgicas.



El sistema puede ejecutarse con estructura abierta, lo que permite la permeabilidad al agua y facilita el drenaje de la humedad. Alternativamente, puede realizarse con estructura cerrada, obteniendo un pavimento impermeable, en cuyo caso es necesario aplicar un barniz sellante como acabado final.

Adicionalmente, ALFOMBRA PIEDRA FLEXIFOR contribuye al aislamiento acústico, permite una rápida ejecución en obra y favorece la absorción del calor ambiental. Su acabado proporciona una sensación cálida y un aspecto uniforme, dando



**BUEN DRENAJE**



**ABSORCIÓN DE CALOR**



**ABSORCIÓN DE SONIDO**



**DURABILIDAD**

# CIRCUITO DEPORTIVO /





## ABDOMINALES

CID-001



## LUMBARES

CID-002



## ESPALDERAS

CID-003



## FLEXIONES

CID-004



## PARALELAS

CID-005



## ESCALERA

CID-006



## PULSO

CID-007



## EQUILIBRIO

CID-008



## VALLAS

CID-009



## ROCÓDROMO

CID-010



## ESCALERA

CID-011

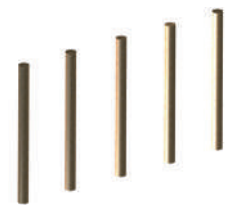

## SLALOM

CID-012



## EQUILIBRIO+

CID-015

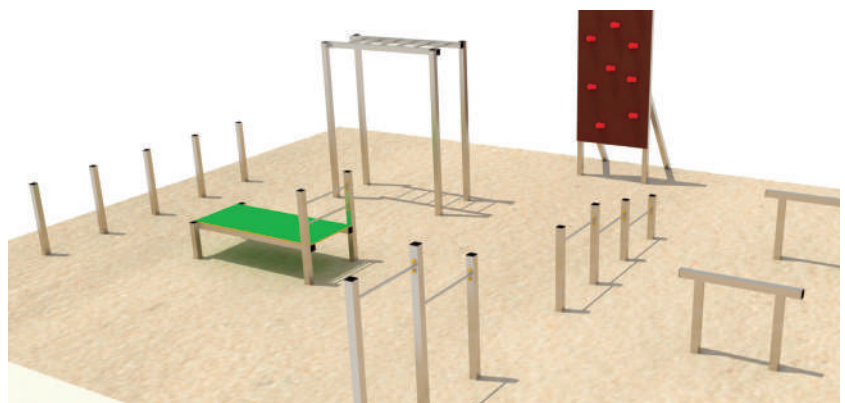

# STREET WORK /

BARRAS  
ACERO INOX

POSTES  
GALVANIZADOS

**SIN  
MANTENIMIENTO**



## DOMINADAS

STR-001

>14  1,32m  1u.

**DIM** 1,43 x 2,51m **ZS** 4,4 x 3,1m



## ESCALERA V.

STR-002

>14  1,32m  1u.

**DIM** 1,43 x 2,51m **ZS** 4,4 x 4,1m



## PARALELAS

STR-003

>14  0,32m  1u.

**DIM** 1,93 x 1,5m **ZS** 4,9 x 3,7m



## DOMINADAS x2

STR-004

>14 ↓ 1,32m ☉ 2u.

**DIM** 2,72 x 2,51m **ZS** 5,7 x 3,1m



## STR-005

STR-005

>14 ↓ 1,32m ☉ 2u.

**DIM** 3,5 x 2,51m **ZS** 6,5 x 4,4m



## SERPIENTE

STR-006

>14 ↓ 1,35m ☉ 1u.

**DIM** 1,93 x 2,51m **ZS** 4,9 x 3,7m



## FLEXIONES

STR-007

>14 ↓ <0,6m ☉ 3u.

**DIM** 4,01 x 1,51m **ZS** 7 x 3,1m

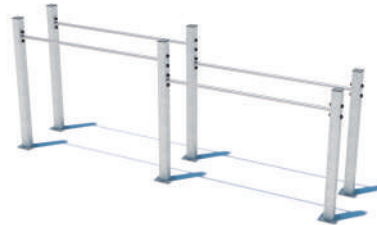

## PARALELA 2 NIV.

STR-008

>14 ↓ <0,6m ☉ 2u.

**DIM** 3,22 x 0,7m **ZS** 6,2 x 3,7m

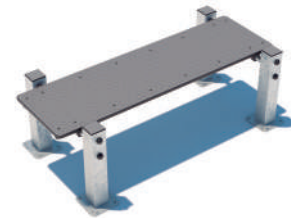

## BANCO H.

STR-009

>14 ↓ <0,6m ☉ 1u.

**DIM** 1,65 x 0,73m **ZS** 4,7 x 3,7m



## BANCO

STR-010

>14 ↓ <0,6m ☉ 1u.

**DIM** 1,58 x 0,73m **ZS** 4,6 x 3,7m



## CUADRADO

STR-011

>14 ↓ 1,32m ☉ 2u.

**DIM** 1,43 x 1,43m **ZS** 4,4 x 4,4m

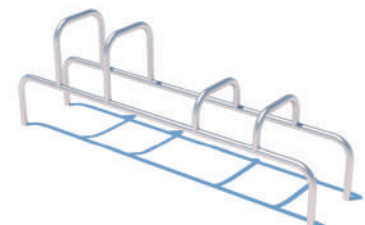

## BANCO DIP

STR-028

>14 ↓ <0,6m ☉ 2u.

**DIM** 2,2 x 0,44m **ZS** 5,1 x 3,4m



## STR-012

STR-012

>14 ↓ 1,32m ☉ 4u.

**DIM** 2,6 x 2,81m **ZS** 5,57 x 5,78m



## STR-013

STR-013

>14 ↓ 1,32m ☉ 7u.

**DIM** 3,68 x 1,89m **ZS** 6,68 x 4,89m

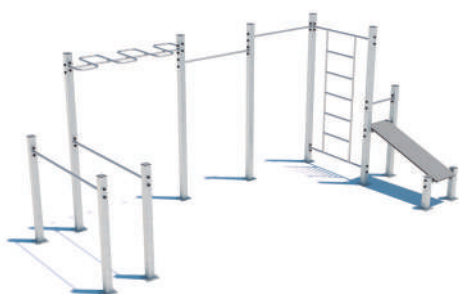

## STR-014

STR-014

>14 ↓ 1,35m ☉ 6u.

**DIM** 5,68 x 3,05m **ZS** 8,66 x 6,05m



## STR-015

STR-015

>14 ↓ 1,35m ☉ 8u.

**DIM** 4,59 x 5,00m **ZS** 7,57 x 7,98m



## STR-016

STR-016

>14 ↓ 1,35m ☉ 10u.

**DIM** 5,88 x 4,99m **ZS** 8,86 x 7,98m



## STR-020

STR-020

>14 ↓ 1,35m ☉ 6u.

**DIM** 4,10 x 3,90m **ZS** 7,40 x 7,07m



## STR-021

STR-021

>14  1,35m  4u.

**DIM** 1,88 x 2,13m **ZS** 5,09 x 4,84m



## STR-022

STR-022

>14  1,35m  4u.

**DIM** 1,88 x 3,49m **ZS** 6,99 x 4,84m



## STR-023

STR-023

>14  1,35m  5u.

**DIM** 4,76 x 6,83m **ZS** 7,64 x 6,79m



## STR-024

STR-024

>14  1,35m  9u.

**DIM** 5,17 x 4,05m **ZS** 8,17 x 6,95m



# STREET PARKOUR /

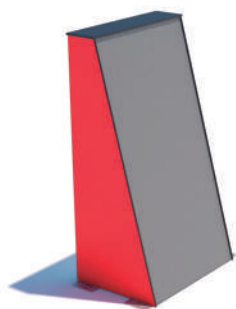

## RAMPA

PRK-001

>14  2,30m  2u.

**DIM** 1,45 x 0,91m **ZS** 5,31 x 4,97m

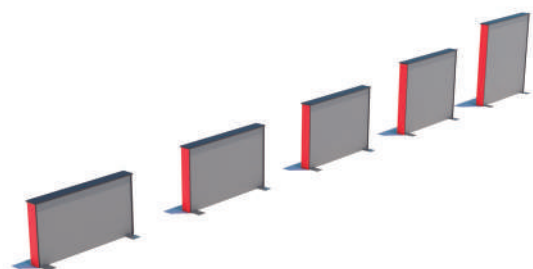

## MURO

PRK-002

>14  1,52m  10u.

**DIM** 0,45 x 11,66m **ZS** 3,17 x 14,66m

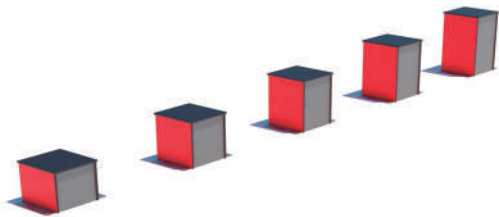

## CAJONES

PRK-007

>14  0,8m  12u.

**DIM** 0,58 x 4,61m **ZS** 3,43 x 7,61m

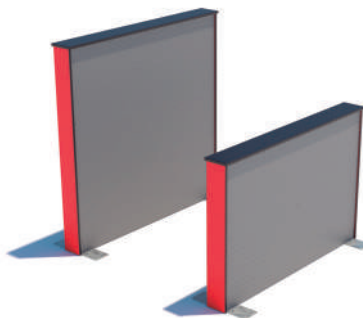

## DOBLE MURO

PRK-004

>14  1,52m  6u.

**DIM** 1,62 x 1,79m **ZS** 4,55 x 4,52m



## CONJUNTO 06

PRK-006

>14  2,12m  7u.

**DIM** 2,85 x 0,45m **ZS** 4,01 x 5,73m

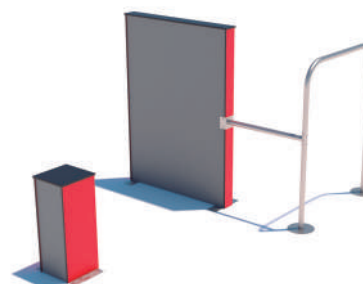

## CONJUNTO 05

PRK-005

>14  2,13m  8u.

**DIM** 4,03 x 2,72m **ZS** 6,92 x 5,56m

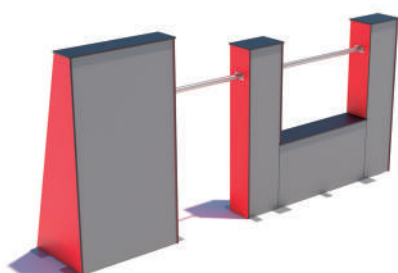

## CONJUNTO 19

PRK-019

>14  <2,3m  7u.

**DIM** 4,77 x 1,03m **ZS** 8,55 x 4,97m

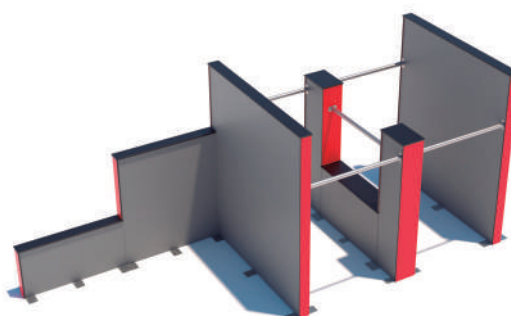

## CONJUNTO 03

PRK-003

>14  2,54m  16u.

**DIM** 6,57 x 2,58m **ZS** 10,12 x 6,81m

# STREET BIOPARQUES /



## BICI

BIO-001

**DIM** 1 x 0,7m

**ZS** 4 x 3,7m



## CORREDOR

BIO-002

**DIM** 1,35 x 0,5m

**ZS** 4,3 x 3,5m



## TRIPLE CINTURA

BIO-004

**DIM** 1,3 x 1,45m

**ZS** 4,5 x 4,3m



## ANDADOR

BIO-013

**DIM** 1,25 x 0,5m

**ZS** 4,2 x 3,5m



## GIRO DE BRAZO

BIO-006

**DIM** 0,9 x 0,94m

**ZS** 3,9 x 3,9m



## PÉNDULO

BIO-007

**DIM** 1,2 x 0,7m

**ZS** 4,2 x 3,7m



## PARALELAS

BIO-008

**DIM** 1,1 x 0,586m **ZS** 4,1 x 3,6m



## RUEDA DE HOMBRO

BIO-011

**DIM** 0,70 x 0,54m **ZS** 3,7 x 3,5m



## REMO

BIO-010

**DIM** 1,18 x 0,53m **ZS** 4,2 x 3,4m



## PIERNAS

BIO-005

**DIM** 2,3 x 0,46m **ZS** 5,31 x 3,46m

## MIXTO

BIO-012

**DIM** 2,04 x 0,4m **ZS** 5,04 x 3,39m



# MAYORES EN FORMA /



## ESCALERA DE DEDOS

MF-002

>14 **DIM** 1,10 x 2,00m **ZS** 4,10 x 3,00m



## ESPALDERA

MF-003



>14 **DIM** 1,10 x 2,00m **ZS** 4,10 x 3,00m

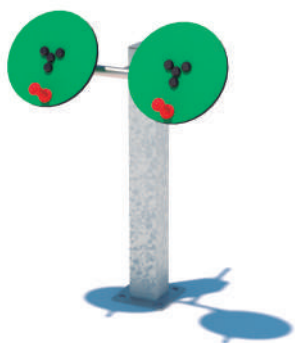

## GIRO DE BRAZOS

BIO-006I



>14 **DIM** 0,90 x 0,60m **ZS** 3,89 x 3,00m



## GIRO DE HOMBRO

MF-010

>14 **DIM** 1,10 x 1,85m **ZS** 4,10 x 3,00m



## BICI DE BRAZO

BIO-016I



>14 DIM 1,30 x 1,01m ZS 4,30 x 4,11m

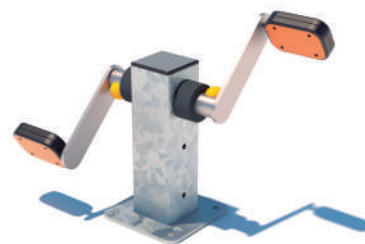

## PEDALES

BIO-014I

>14 DIM 1,30 x 1,01m ZS 4,30 x 4,11m



## MUÑECA + SEGUIDOR

MF-008



>14 DIM 1,30 x 1,01m ZS 4,30 x 4,11m



## GIRO DE MUÑECAS

MF-009



>14 DIM 1,30 x 1,01m ZS 4,30 x 4,11m



## MUÑECA + AGARRE

MF-004



>14 DIM 1,10 x 1,35m ZS 4,10 x 3,00m

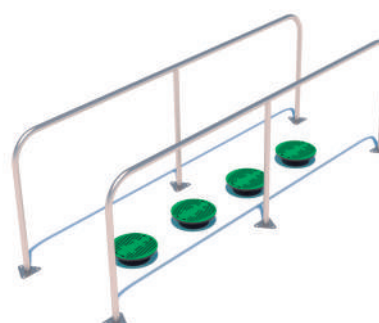

## OBSTÁCULOS

BIO-017

>14 DIM 2,80 x 0,84m ZS 5m80 x 3,84m



# PISTAS DEPORTIVAS /

## **Tan importante es el juego como el deporte.**

Basados en mismos conceptos y pilares principales, ayudamos a difundir y a practicar el deporte en las zonas públicas, instalando pistas deportivas que permiten el desarrollo de deportes como fútbol, baloncesto y todas sus variantes.

Pistas fabricadas en estructura metálica y lamas de madera o PEHD, de alta resistencia y buenos acabados, cumpliendo la normativa vigente al respecto.

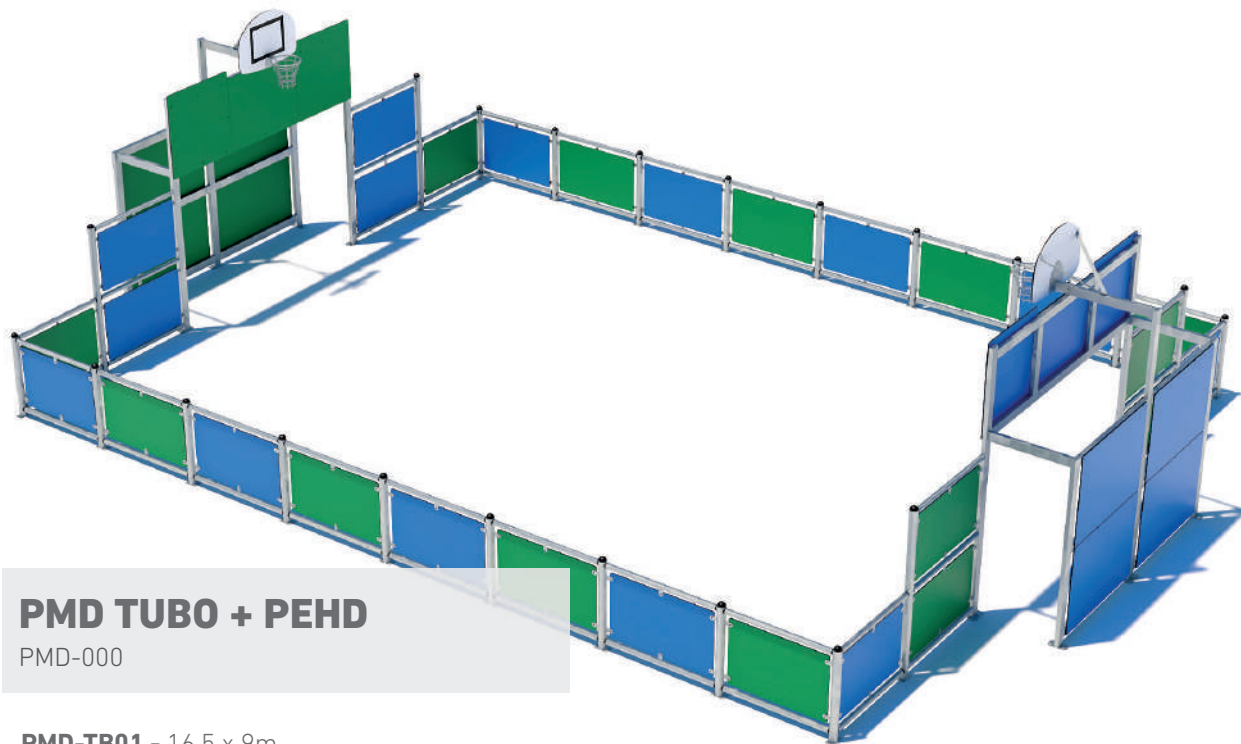

## PMD TUBO + PEHD

PMD-000

**PMD-TB01** - 16,5 x 9m

**PMD-TB02** - 21 x 12m

**PMD-TB03** - 30 x 15m

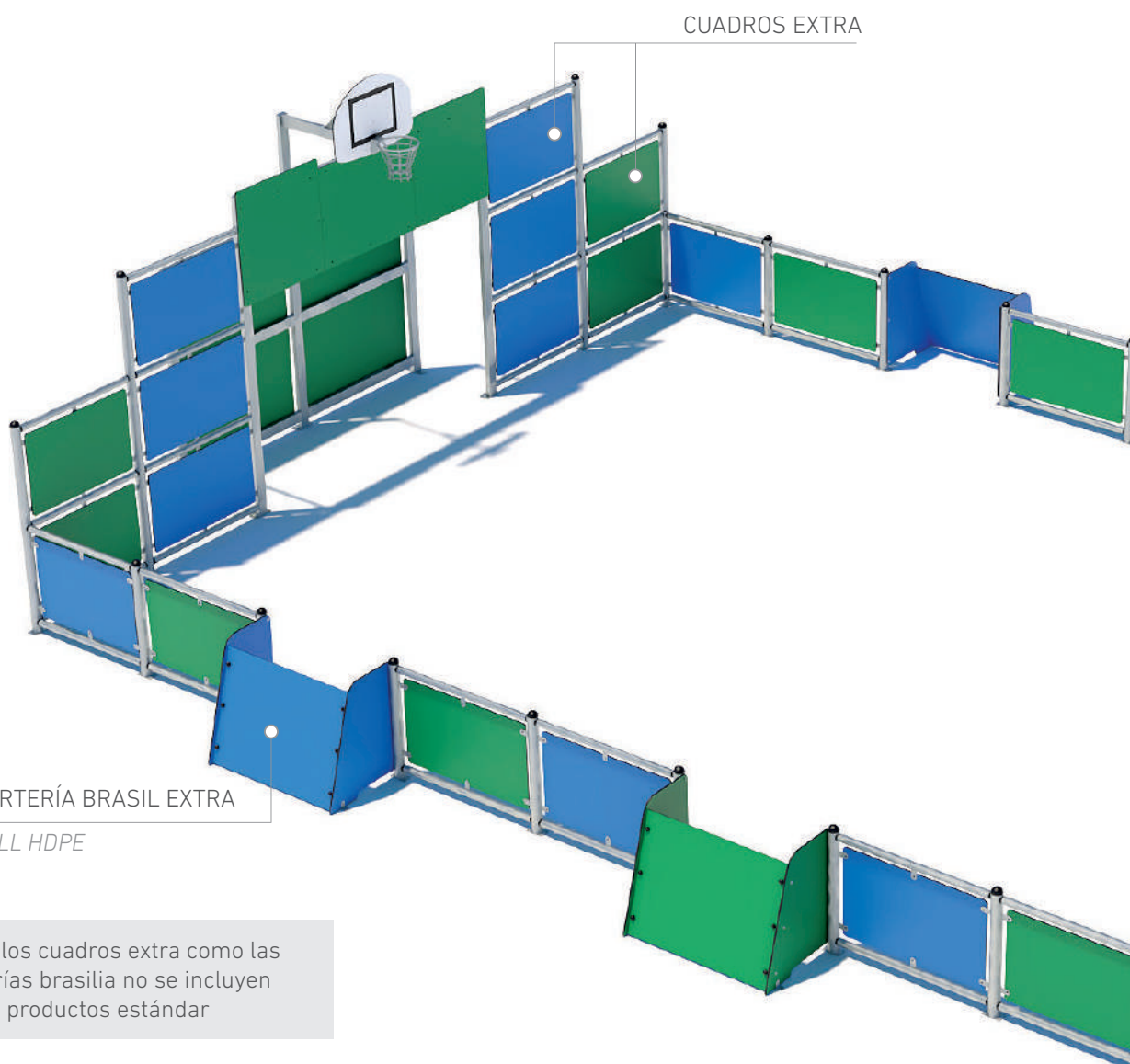

CUADROS EXTRA

PORTERÍA BRASIL EXTRA

FULL HDPE

Tanto los cuadros extra como las porterías brasilia no se incluyen en los productos estándar

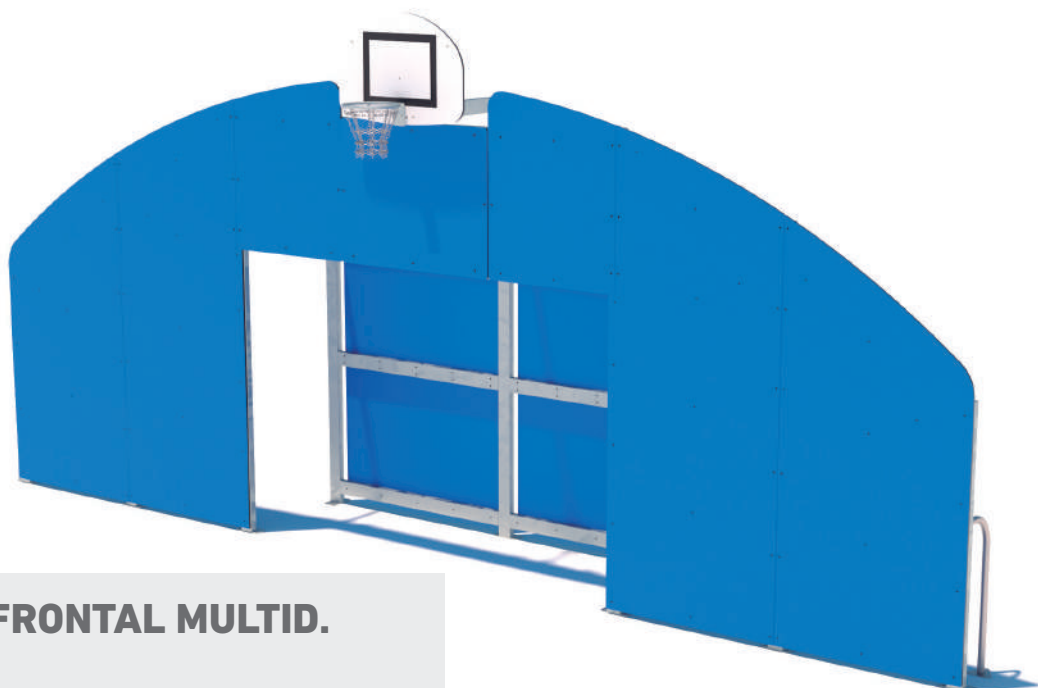

**FMD FRONTAL MULTID.**

FMD-001



**FMD FRONTAL MULTID.**

FMD-002

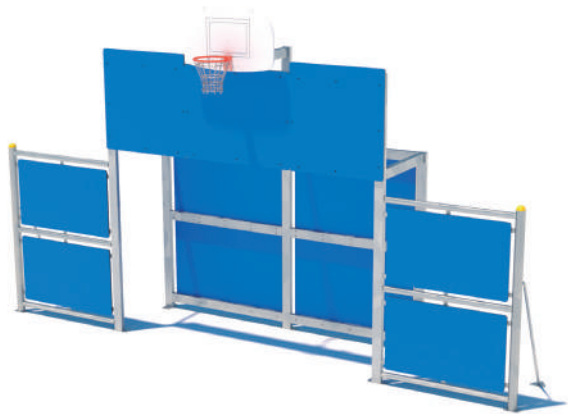

### FRONTAL MULTID. 2P

PMD-FR1

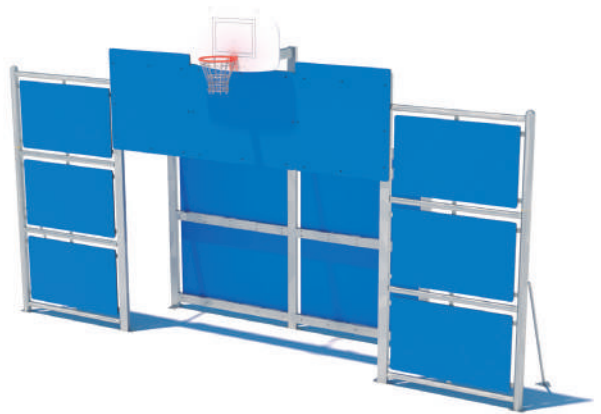

### FRONTAL MULTID. 3P

PMD-FR2

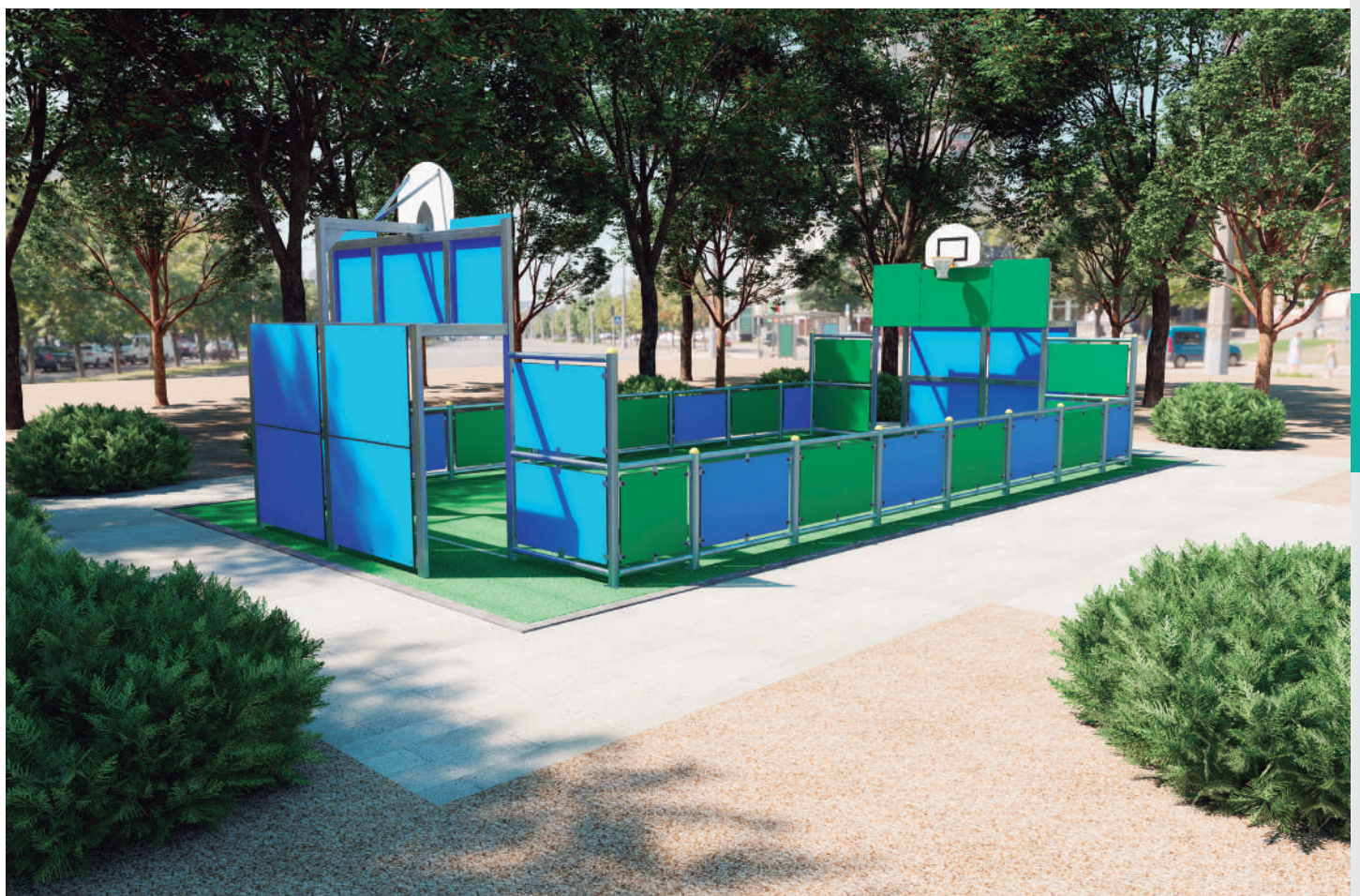

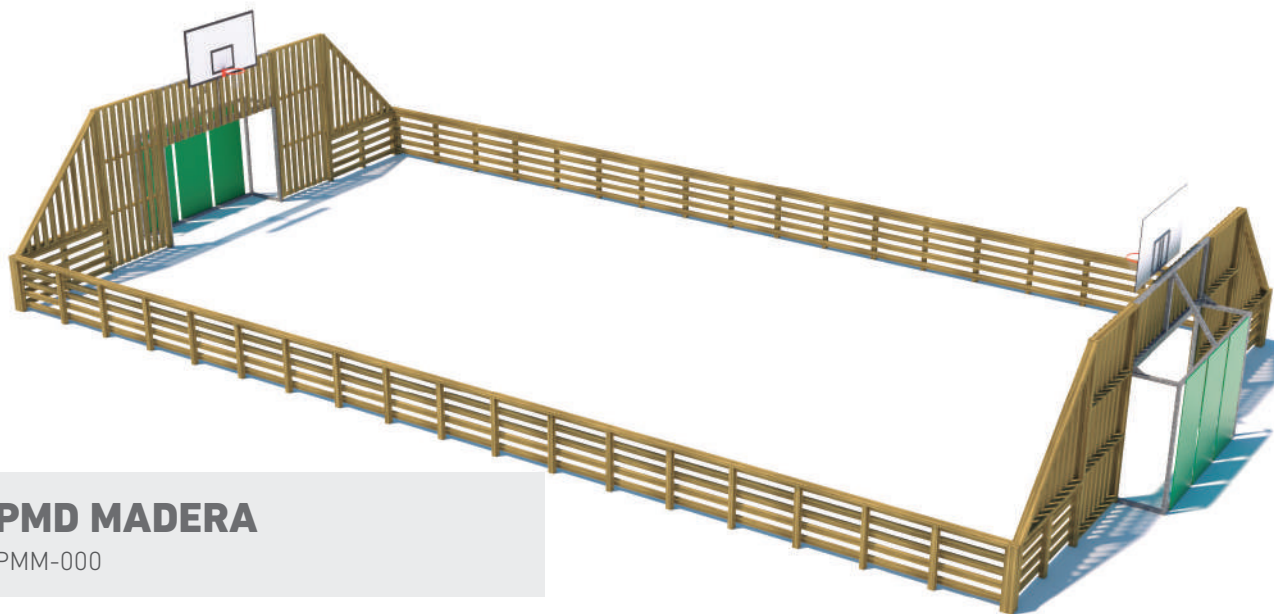

## **PMD MADERA**

PMM-000

**PMD-MM2** - 20 x 12m

**PMD-MM3** - 30 x 15m

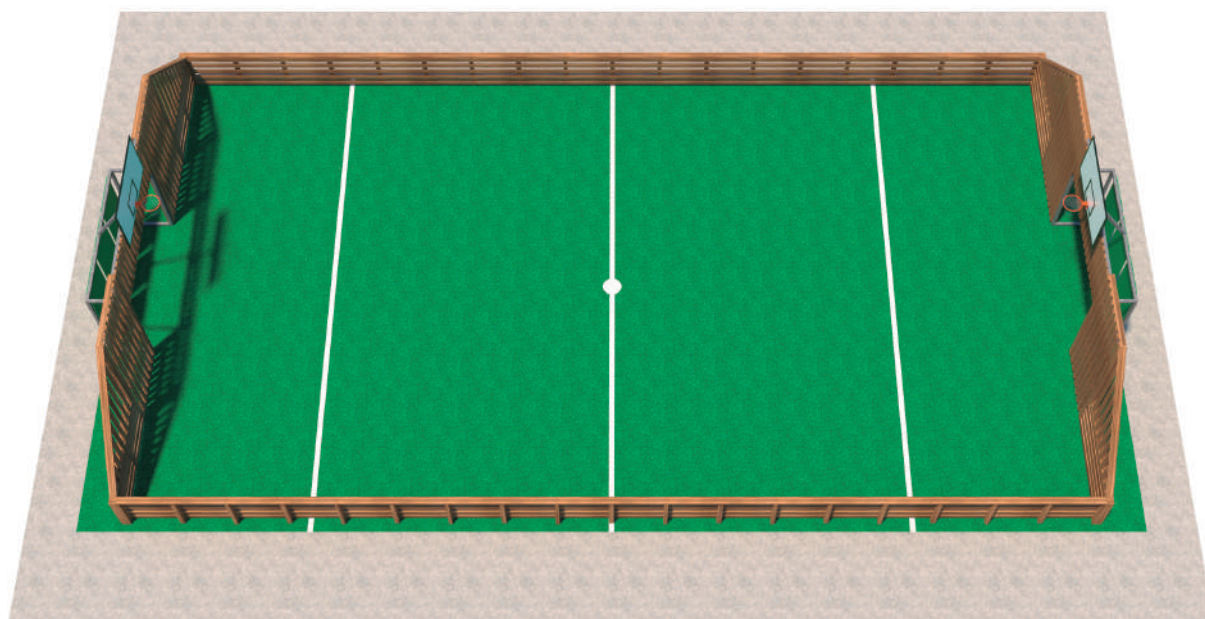





# VELAS TENSADAS **CUBRICIONES /**



**sunfor** 

## **ESTRUCTURAS Y SOMBRAS** *PARA ZONAS PÚBLICAS*

---

Diseñamos y desarrollamos estructuras personalizadas y a medida como método de cubrición y sombra para zonas públicas, especialmente zonas de juego.

La instalación de este tipo de estructuras tensadas afecta directamente a la zona de instalación y a los productos instalados:

- Alarga la vida de los productos, al ofrecer protección contra agentes medioambientales.
- Aumenta las horas y franjas horarios de uso, al permitir disfrutar de las instalaciones en horas de mayor incidencia solar o lluvia fina.
- Mejora la experiencia de uso.
- Ayuda a la integración natural y visual con el entorno, aportando diseño arquitectónico urbano.





## TEJIDO TENSADO

Commercial 95

- posibilidad ignífugo
- gran variedad de colores
- posibilidad duotono

## TENSOR MECÁNICO

- tensores galvanizados
- doble varilla con puño

## PILARES

- imprimación + termolacado
- sección según proyecto

## PROTECTORES

posibilidad de servicio de protectores de pilares a medida





# VELAS ORGÁNICAS SOMBRA /



Presentamos nuestra nueva vela para protección solar, fabricada en malla de poliéster con cortes en "C" y cableado interior de nailon, con un índice de sombreado del 85%, totalmente transpirable, de gran ligereza técnica y visual, permitiendo hacer grandes superficies de sombra con estructura ligera.

Por su fabricación y cortes, ofrece una transpirabilidad total frente a vientos fuertes, siendo una vela de gran seguridad.

El tejido cuenta con tratamientos anti-UV, anti reflejos y anti brillo, con garantía anti moho, tejido de gran flexibilidad y fácil cuidado, lo que garantiza una larga vida de producto.



PROTECCIÓN  
85%



ADAPTABILIDAD



TRANSPIRABLE



DURABILIDAD

## FÁCIL INSTALACIÓN

tejido muy ligero, con fijación mediante mosquetones a cable perimetral. Incluye punto de tensado mediante polea o tensor mecánico.

## ESTRUCTURA SUPER LIGERA

con pilares para fundir a hormigón o sobre dados de hormigón pref.



## GRAN ADAPTABILIDAD

para cubrir grandes superficies, con poca inversión y tiempo. Instalación sobre pilares o herrajes a pared.

CONFIGURA  
TU SOMBRA  
**A MEDIDA**

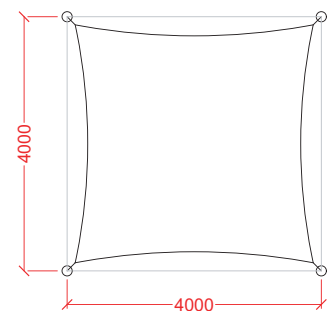
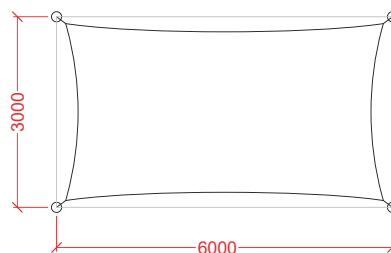

# CANINOS AGILITY /



## MOBILIARIO URBANO PARA MASCOTAS

---

Pasamos y dedicamos mucho tiempo a nuestras mascotas. Es necesario alimentarlos, mimarlos, pasear con ellos... uno de los aspectos primordiales en la relación dueño-mascota es el afecto y la compenetración.

Ofrecemos una nueva versión actualizada de agility pensada para todo tipo de mascotas, no sólo para perros. Adaptado tanto en materiales como en estética, este nuevo equipamiento urbano sirve para que la relación con nuestros compañeros se fortalezca, ayudando a mantener la salud tanto física como mental del animal.

Los productos agility han sido diseñados especialmente para una integración natural dentro de su entorno, usando los mismos materiales que en los parques infantiles, respetando los criterios y recomendaciones de normativas vigentes.

Estética actualizada, durabilidad de producto y calidad asegurada tanto en material como en acabados, la serie AGILITY es una apuesta segura.





## PUERTA

PPE-001

**DIM** 1,0 x 1,0m  0,75m

**MDR** **HRC**



## MURO

PPE-002

**DIM** 1,0 x 1,0m  0,65m

**MDR** **HRC**



## SALTO

PPE-003

**DIM** 1,0 x 1,0m  0,90m

**MDR** **HRC**

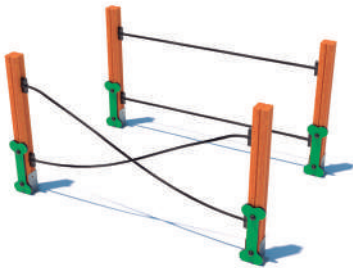

## CUERDAS

PPE-004

**DIM** 1,8 x 1,0m  0,65m

**MDR** **HRC**

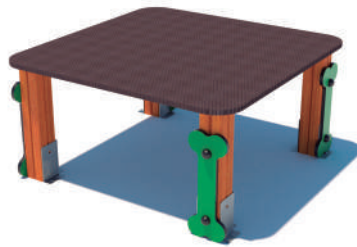

## PLATAFORMA

PPE-005

**DIM** 0,9 x 0,9m  <0,6m

**MDR** **HRC**

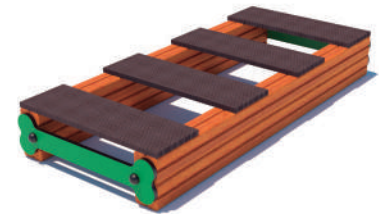

## PISADA

PPE-006

**DIM** 1,4 x 0,6m  0,1m

**MDR** **HRC**

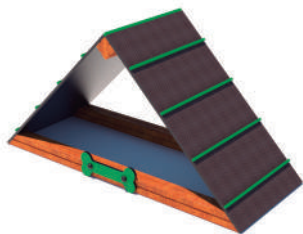

## BARRERA PEQ.

PPE-007

**DIM** 1,7 x 0,6m  0,85m

**MDR** **HRC**

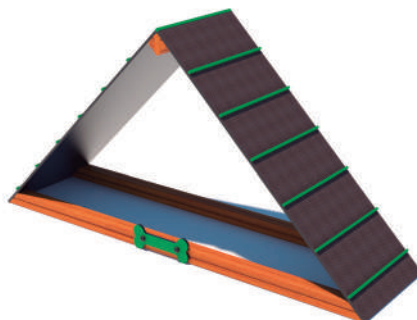

## BARRERA

PPE-007A

**DIM** 2,6 x 0,6m  1,30m

**MDR** **HRC**

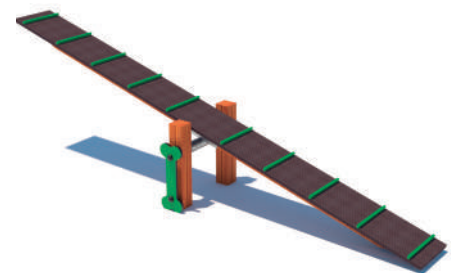

## BALANCEO

PPE-008

**DIM** 3 x 0,4m  0,55m

**MDR** **HRC**



## PUENTE

PPE-009

**DIM** 1,5 x 0,3m  0,90m

**MDR** **HRC**



## TÚNEL 2m

PPE-010

**DIM** 1,0 x 1,1m  <0,6m

 2,4m **MDR** **HRC**



## TÚNEL 1m

PPE-010A

**DIM** 1,0 x 1,1m  <0,6m

 1,3m **MDR** **HRC**



## SLALOM (uds)

PPE-011 (6, 8, 10 ó 12uds)

**DIM** 1m  <0,6m

 0,55m x5 **MDR** **HRC**

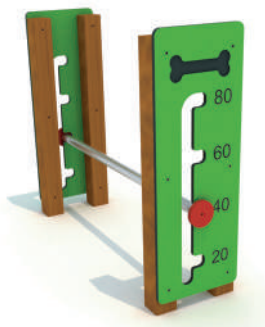

## SALTO ALTURA

PPE-012

**DIM** 1,3 x 0,4m  0,80m

**MDR** **HRC**



## PARKING

PPE-014

**DIM** --

**LAC**



## FUENTE

FUE-037

**DIM** 1,35 x 1,81m

**LAC**



## DISPENSADOR

PPE-015

**DIM** --

**LAC**



## DISPENSADOR

PPE-0015A

**DIM** --

**LAC**



# URBAN **SKATE /**





## QUARTER PIPE

PS-01

A	B	C
1,2m	2,94m	2,44m
1,5m	3m	2,44m

## BANK

PS-04

A	B	C
1,2m	2,94m	2,44m
1,5m	3m	2,44m

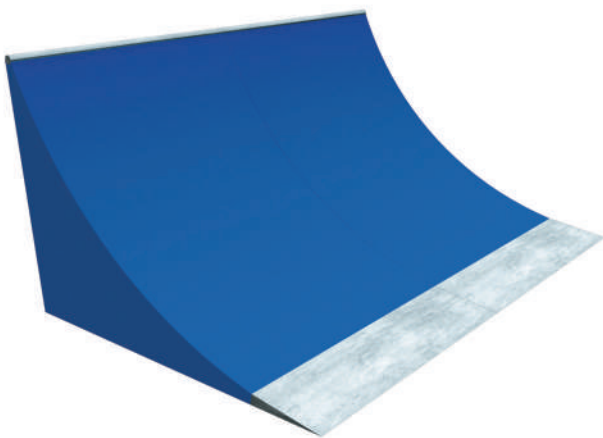

## QUARTER MINI RAMP

PS-03

A	B	C
1m	1,59m	2,44m

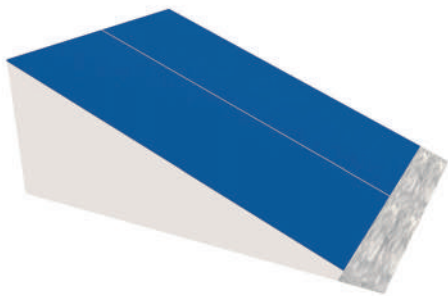

## BANK MINI RAMP

PS-06

A	B	C
1m	2,12m	2,44m

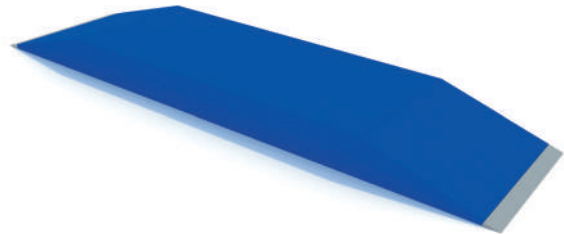

## GRIND BOX

PS-08

A	B	C
0,6m	1,22m	7,13m
0,9m	1,22m	7,13m



## GRIND BOX + HUBBA

PS-08 + PS-10

A	B	C
0,6m	7,13m	2,44m
0,9m	7,13m	2,44m

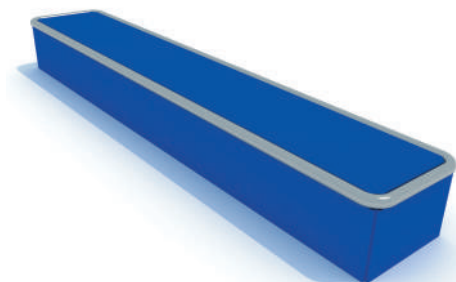

## PLANTER

PS-20

A	B	C
0,25m	3,00m	0,5m



## HUBBA

PS-10

A	B	C
0,6m	7,13m	0,6m
0,9m	7,13m	0,6m

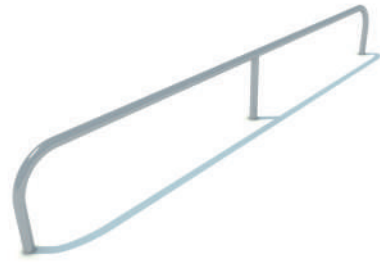

## RAIL 3m

PS-24-3

A	B	C
0,4m	3m	-

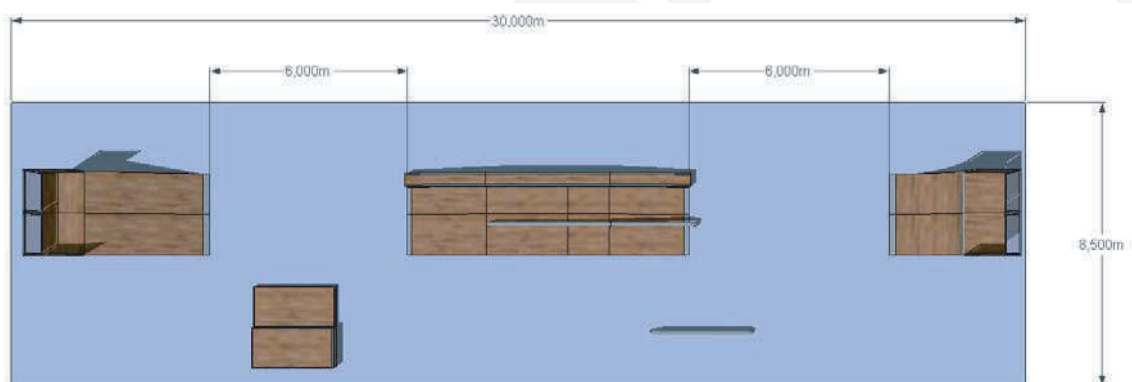
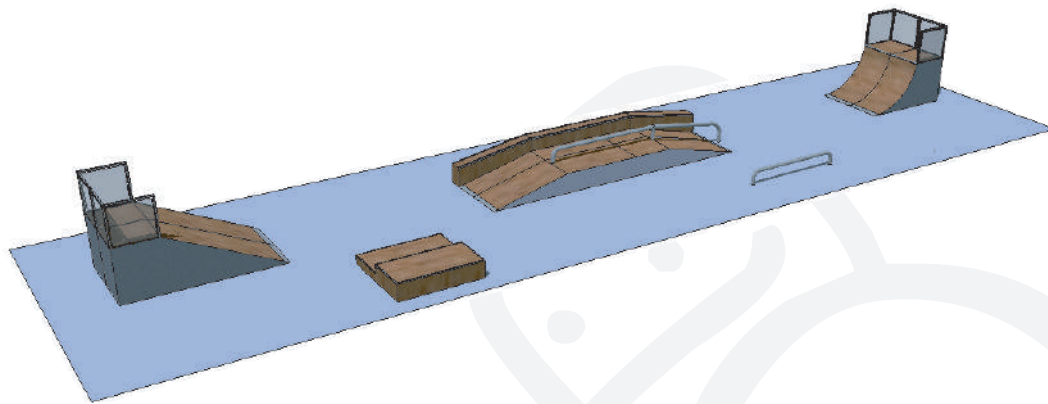

# MOSSER

industrias

playfor

  
sunfor

flexifor



**INDUSTRIAS MOSSER 97, S.L.**  
CALLE AFRICA, 15 - P.I. LA SERRETA  
30500 MOLINA DE SEGURA (Murcia)  
T · 968 823 362 | info@industriasmosser.com

  
[www.industriasmosser.com](http://www.industriasmosser.com)